



MK
LINE
by Mirtak

COLLECTION 23

GRIFERÍA Y ACCESORIOS BAÑO
MIXERS & BATH ACCESSORIES

www.mirtak.com

Water is the Future



ÍNDICE

INDEX · INDICE · ÍNDICE

10

MK LINE SERIES



76

OTHER SHOWER COLUMN MIXERS

OTRAS COLUMNAS



84

ESSENCE COLLECTION

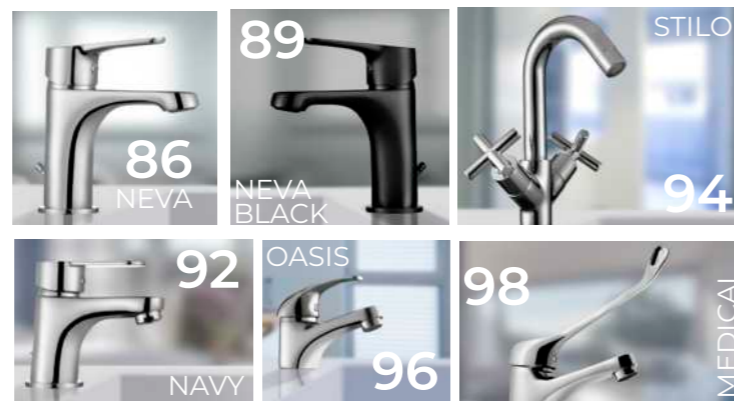

100

GRIFERÍA TERMOSTÁTICA
THERMOSTATIC MIXERS



106

KITCHEN MIXERS

GRIFERÍA COCINA



122

ELECTRONIC TAPS

GRIFERÍA ELECTRÓNICA



126

TIMER TAPS

GRIFERÍA TEMPORIZADA



130

GRIFERÍA EMPOTRADA Y PEDALES

BUILT-IN MIXERS AND PEDALS



134

ACCESSORIES

ACCESORIOS

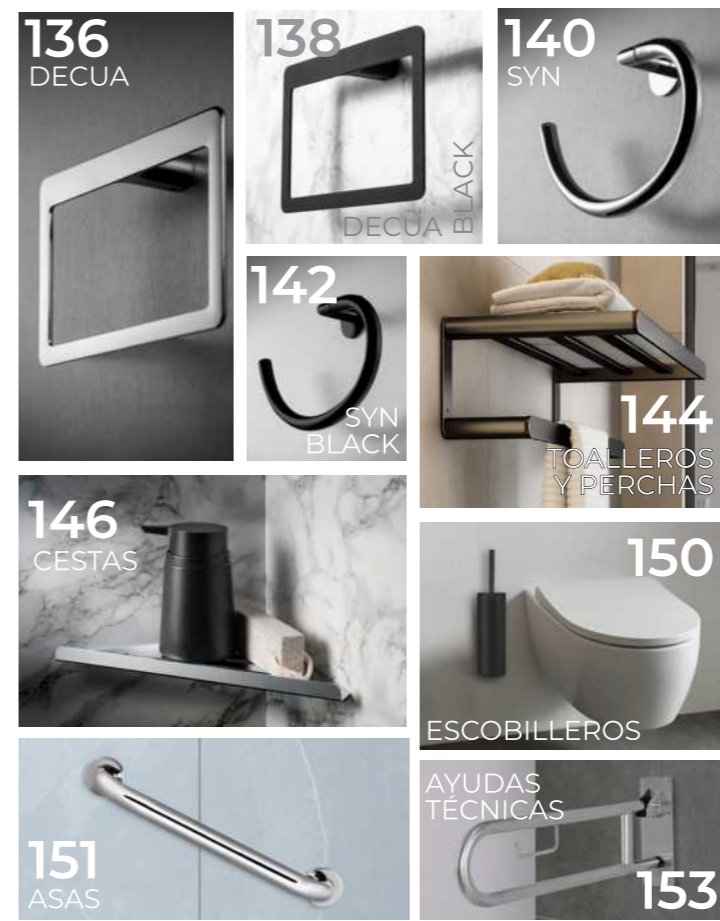

154

COMPLEMENTOS GRIFERÍA
TAP ACCESSORIES



160

COMPLEMENTOS DUCHA
SHOWER ACCESSORIES



170

EXPOSITORES
DISPLAYS



176

RECAMBIOS GRIFERÍA
MIXER REPLACEMENTS



EL AGUA THE WATER

*Hay que disfrutarla y a la vez preservarla.
We should enjoy it while preserving it.*

Solo el
Only the

1%

del agua en el mundo
es POTABLE.
of the worldwide water
is DRINKABLE.



PK
LINE

Grifería de diseño sostenible
Sustainable design taps

Con un simple concepto en mente:
With a simple concept in mind:

“Menos es más”

“Less is more”

*menos impacto, más diseño.
less impact, more design.*



Acabados / Finishes

-  Cromo
Chrome
-  Negro Mate
Matt black
-  Pomo **mármol blanco**
Cuerpo cromo
White marble knob
Chrome body
-  Pomo **mármol negro**
Cuerpo cromo
Black marble knob
Chrome body
-  Maneta **oro dark**
Cuerpo negro mate
Dark gold handle
Matt black body
-  Pomo negro (efecto granito)
Cuerpo cromo
Black knob (granite effect)
Chrome body
-  Pomo gris claro (efecto granito)
Cuerpo negro mate
Light grey knob (granite effect)
Matt black body
-  Pomo negro (efecto granito)
Cuerpo negro mate
Black knob (granite effect)
Matt black body

Tecnología MK Line
MK Line technology



Acabados con más dureza y 0 emisiones
Finishes with more hardness and 0 emissions



Sistema PRESS - START / STOP
PRESS system - START / STOP





































-30%

Mediante
Through





Cartuchos o aireadores
Cartridges or aerators

| | Lavabo Washbasin mixer | Lavabo alto High washbasin mixer | Bidé Bidet mixer |
|------------------------------------|--|---|---|
| ERA (pg.12 - pg.19) |  |  |  |
| VITA (pg.20 - pg.27) |  |  |  |
| QUO (pg.28 - pg.35) |  |  |  |
| PLATINUM (pg.36 - pg.39) |  |  |  |
| PRESS (pg.40 - pg.41) |  | |  |
| MAIA (pg.42 - pg.53) |  |  |  |
| SVELTA (pg.54 - pg.65) |  |  |  |
| VEGA (pg.66 - pg.69) |  |  |  |
| TENNA (pg.70 - pg.73) |  | |  |
| YUKON (pg.74 - pg.75) |  | |  |

| Fregadera Sink mixer | Lavabo empotrado Wall washbasin mixer | Monomando ducha empotrado Single lever concealed | Monomando baño Single lever bath mixer | Monomando ducha Single lever shower mixer | Columna ducha Shower column | Columna ducha-baño Shower-bath column |
|---|---|---|---|---|---|---|
| |  |  | | |  | |
| |  |  | | | | |
| |  |  | | | | |
| |  |  | | |  | |
| | | | | |  | |
|  | |  |  |  |  |  |
|  | |  |  | |  |  |
|  | |  |  |  |  | |
|  | |  |  |  |  | |
| | | |  |  | | |

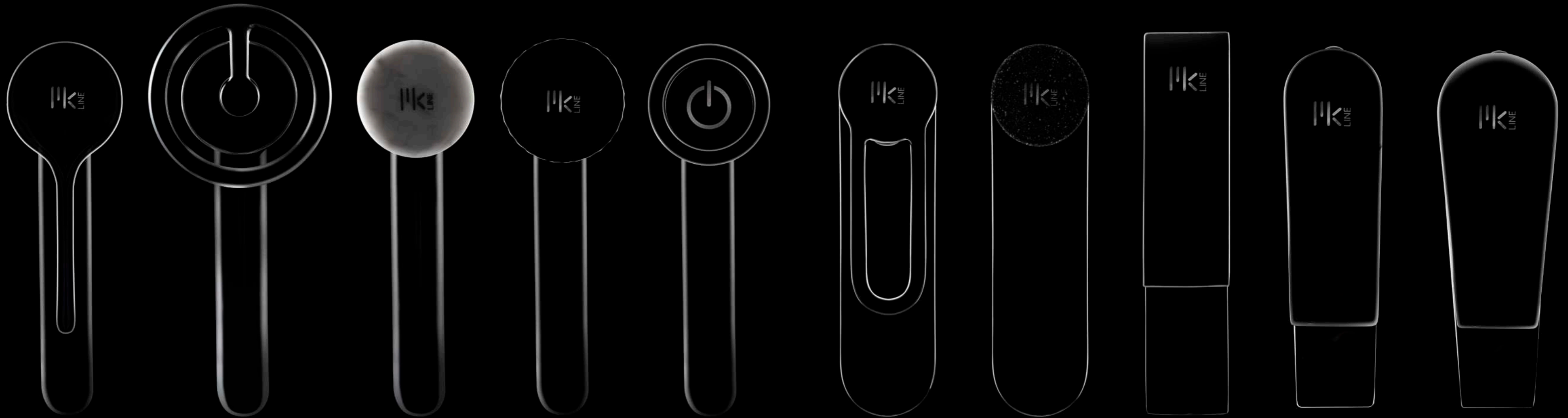

*menos impacto, más diseño.
less impact, more design.*



ERA

VITA

QUO

PLATINUM

PRESS

MAIA

SVELTA

VEGA

TENNA

YURON



Serie
ERA

ACABADO
FINISH



Cromo
Chrome



REF. 68436

Ø 26

MONOMANDO LAVABO ALTO

High lever wash-basin mixer
Mitigeur lavabo haut
Monocomando lavatório alto

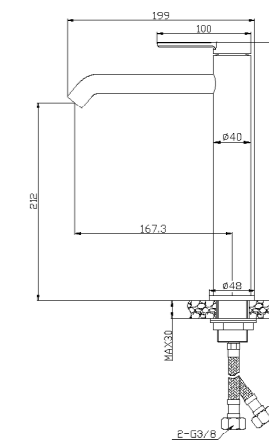

REF. 68431

Ø 26

MONOMANDO LAVABO

Single lever wash-basin mixer
Mitigeur lavabo
Monocomando lavatório

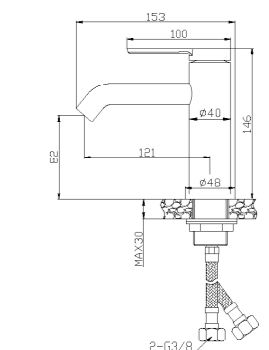

REF. 68432

Ø 26

MONOMANDO BIDÉ

Single lever bidet mixer
Mitigeur bidet
Monocomando bidé

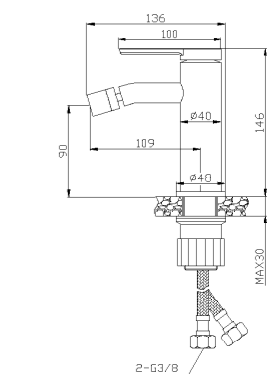

REF. 68437

Ø 35

MONOMANDO EMPOTRADO LAVABO

Built-in single lever washbasin mixer
Mitigeur lavabo à encastrer
Monocomando lavatorio embutida

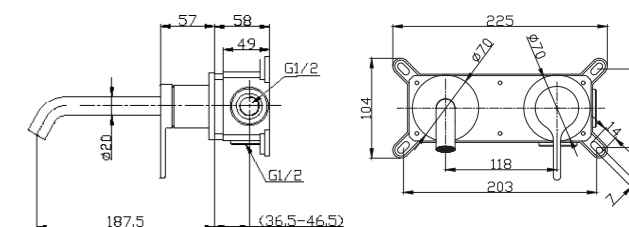

* Instalación con cajetín empotrado

Installation with recessed box
Installation avec boîtier d'encastrement
Instalação com caixa embutida

COMBINA CON...
MATCHES WELL WITH...



DECUA

pg. 136



CESTAS LINE

pg. 146



CLIC-CLAC

pg. 156

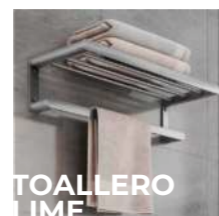

TOALLERO
LINE

pg. 144

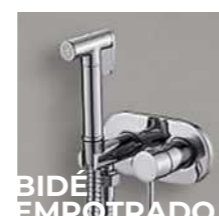

BIDE
EMPOTRADO

pg. 133

SET EMPOTRADO DUCHA MONOMANDO Ø35

AISI 304



- S ROCIADOR
- L Sprayer
- I Pulvérisateur
- M Pulverizador

- FLEJO AISI 304
- Shower hose
- Flexible douche
- Manguera chuveiro

- MANGO TUBI
- Shower handle
- Douchette
- Chuveiro



REF. 68438

REF. 68439

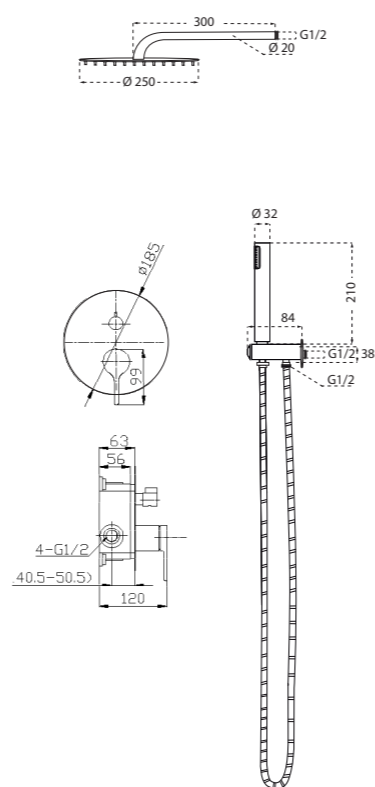

COLUMNA DUCHA MONOMANDO Ø 35

AISI 304



- S ROCIADOR
- L Sprayer
- I Pulvérisateur
- M Pulverizador

- REGULABLE EN ALTURA
- Height adjustable
- Réglable en hauteur
- Ajustável em altura

- FLEJO AISI 304
- Shower hose
- Flexible douche
- Manguera chuveiro

- MANGO ERA
- Shower handle
- Douchette
- Chuveiro



REF. 68430

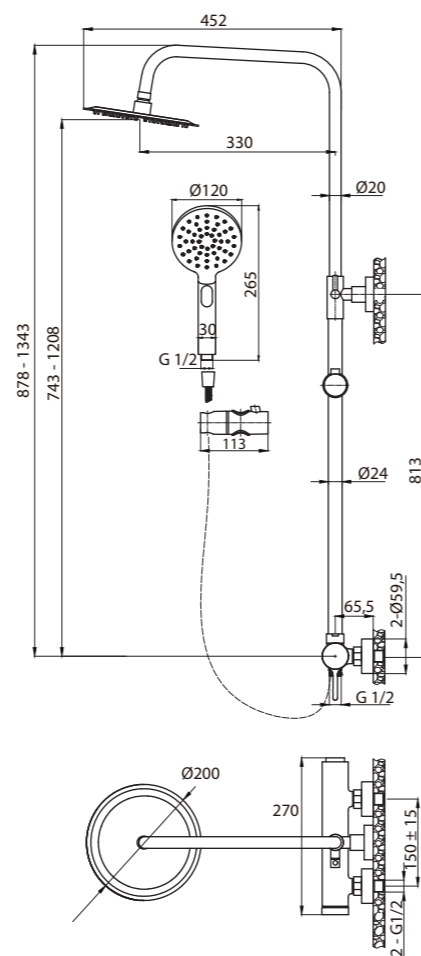



ACABADO
FINISH



Negro mate
Matt black



REF. 68446

Ø 26

MONOMANDO LAVABO ALTO
High lever wash-basin mixer
Mitigeur lavabo haut
Monocomando lavatório alto

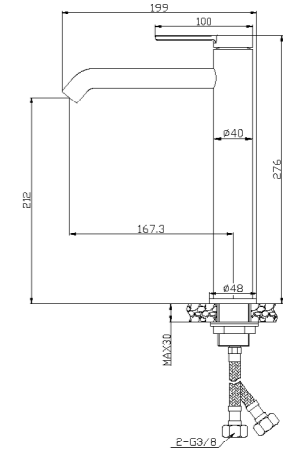

REF. 68441

Ø 26

MONOMANDO LAVABO
Single lever wash-basin mixer
Mitigeur lavabo
Monocomando lavatório

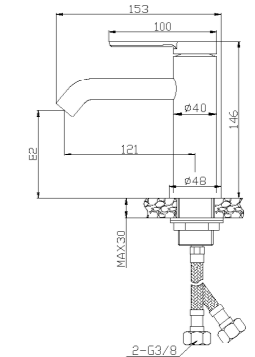

REF. 68442

Ø 26

MONOMANDO BIDÉ
Single lever bidet mixer
Mitigeur bidet
Monocomando bidé

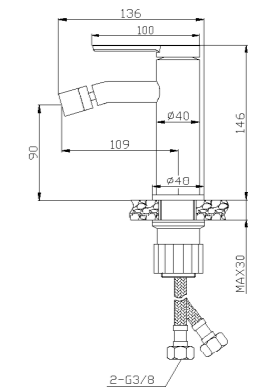

REF. 68447

Ø 35

MONOMANDO EMPOTRADO LAVABO
Built-in single lever washbasin mixer
Mitigeur lavabo à encastrer
Monocomando lavatorio embutida

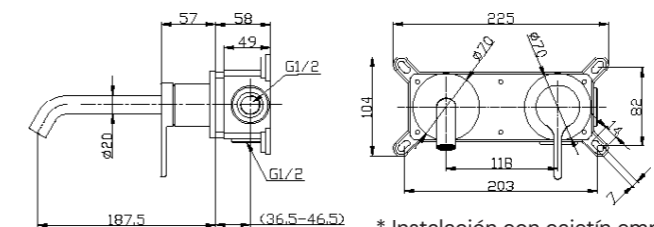

* Instalación con cajetín empotrado
Installation with recessed box
Installation avec boîtier d'encastrement
Instalação com caixa embutida



COMBINA CON...
MATCHES WELL WITH...



DECUA BLACK

pg. 138



CESTAS LIME

pg. 146



CLIC-CLAC

pg. 156

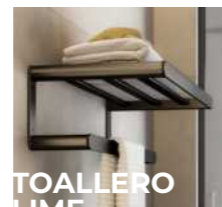

TOALLERO
LIME

pg. 144



ESCOBILLERO
DUAL

pg. 150

SET EMPOTRADO DUCHA MONOMANDO Ø35

AISI 304



S ROCIADOR
L Sprayer
I Pulvérisateur
M Pulverizador

FLEJO AISI 304
Shower hose
Flexible douche
Mangueira chuveiro

MANGO TUBI BLACK
Shower handle
Douchette
Chuveiro

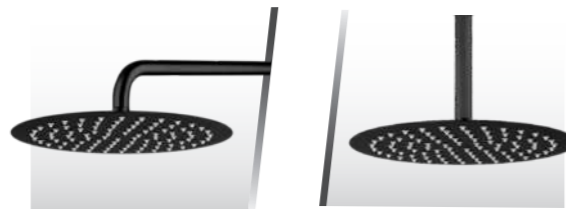

REF. 68448

REF. 68449

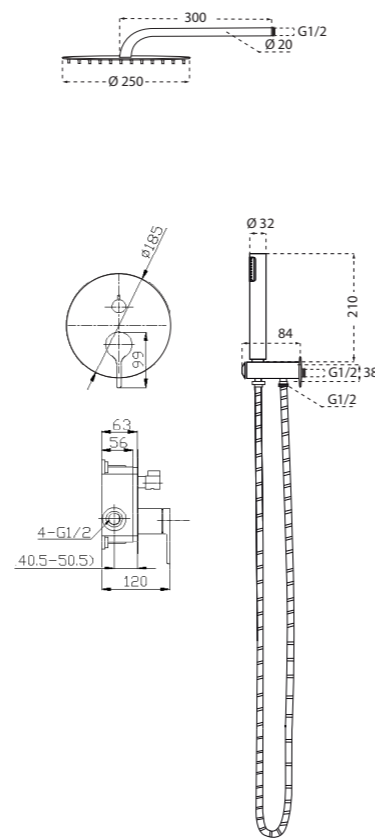

COLUMNA DUCHA MONOMANDO Ø 35

AISI 304



S ROCIADOR
L Sprayer
I Pulvérisateur
M Pulverizador

REGULABLE EN ALTURA
Height adjustable
Réglable en hauteur
Ajustável em altura

FLEJO AISI 304
Shower hose
Flexible douche
Mangueira chuveiro

MANGO ERA BLACK
Shower handle
Douchette
Chuveiro



REF. 68440

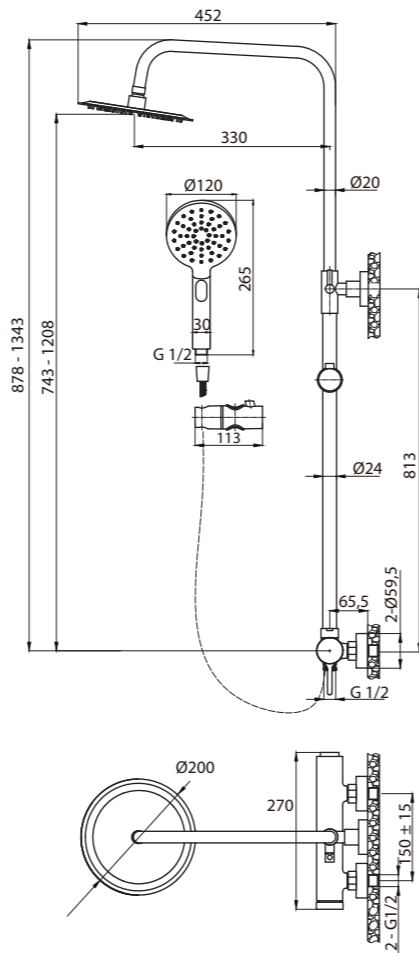



Serie VITA

ACABADO FINISH



Cromo Chrome

COMBINA CON... MATCHES WELL WITH...



SYN

pg. 140



CESTAS LIME

pg. 146



SIFONES

pg. 158

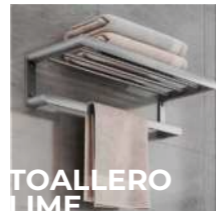

TOALLERO LIME

pg. 144



BIDÉ EMPOTRADO

pg. 133



REF. 68456

Ø 26

MONOMANDO LAVABO ALTO

High lever wash-basin mixer
Mitigeur lavabo haut
Monocomando lavatório alto

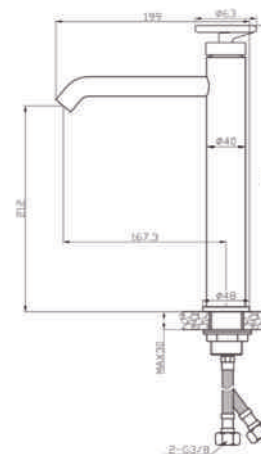

REF. 68451

Ø 26

MONOMANDO LAVABO

Single lever wash-basin mixer
Mitigeur lavabo
Monocomando lavatório

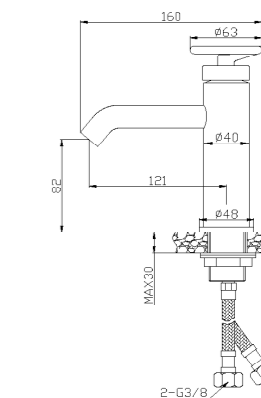

REF. 68452

Ø 26

MONOMANDO BIDÉ

Single lever bidet mixer
Mitigeur bidet
Monocomando bidé

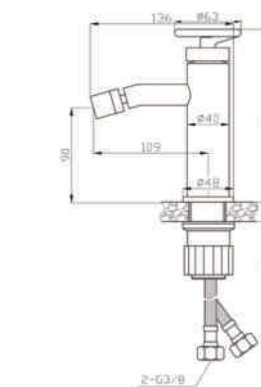

REF. 68457

Ø 35

MONOMANDO EMPOTRADO LAVABO

Built-in single lever washbasin mixer
Mitigeur lavabo à encastrer
Monocomando lavatorio embutido

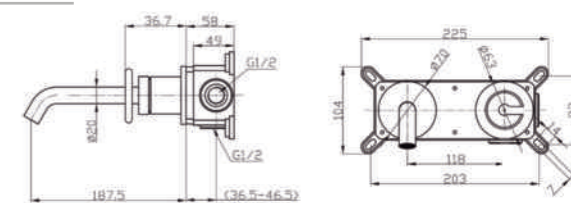

* Instalación con cajetín empotrado

Installation with recessed box
Installation avec boîtier d'encastrement
Instalação com caixa embutida



SET EMPOTRADO DUCHA MONOMANDO Ø35

AISI 304

- S ROCIADOR
- L Sprayer
- I Pulvérisateur
- M Pulverizador

- FLEXP AISI 304
- Shower hose
- Flexible douche
- Mangueira chuveiro

- MANGO TUBI
- Shower handle
- Douchette
- Chuveiro



REF. 68458

REF. 68459





Serie
VITA BLACK

**ACABADO
FINISH**



Negro mate
Matt black

COMBINA CON...
MATCHES WELL WITH...



DECUA BLACK

pg. 138



CESTAS LIME

pg. 146



CLIC-CLAC

pg. 156



TOALLERO
LIME

pg. 144



ESCOBILLERO
DUAL

pg. 150



REF. 68466

Ø 26

MONOMANDO LAVABO ALTO

High lever wash-basin mixer
Mitigeur lavabo haut
Monocomando lavatório alto

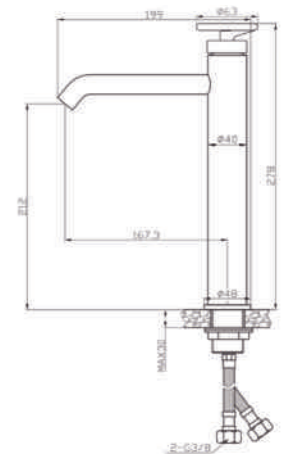

REF. 68461

Ø 26

MONOMANDO LAVABO

Single lever wash-basin mixer
Mitigeur lavabo
Monocomando lavatório

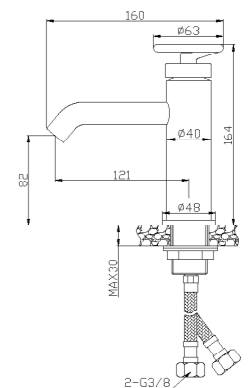

REF. 68462

Ø 26

MONOMANDO BIDÉ

Single lever bidet mixer
Mitigeur bidet
Monocomando bidé

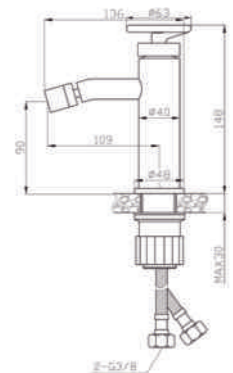

REF. 68467

Ø 35

MONOMANDO EMPOTRADO LAVABO

Built-in single lever washbasin mixer
Mitigeur lavabo à encastrer
Monocomando lavatorio embutida

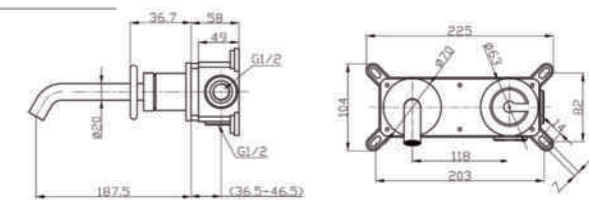

* Instalación con cajetín empotrado

Installation with recessed box
Installation avec boîtier d'encastrement
Instalação com caixa embutida



SET EMPOTRADO DUCHA MONOMANDO Ø35

AISI 304

- S** ROCIADOR
- L** Sprayer
- I** Pulvérisateur
- M** Pulverizador

- FLEJO AISI 304**
- Shower hose
- Flexible douche
- Manguera chuveiro

- MANGO TUBI BLACK**
- Shower handle
- Douchette
- Chuveiro

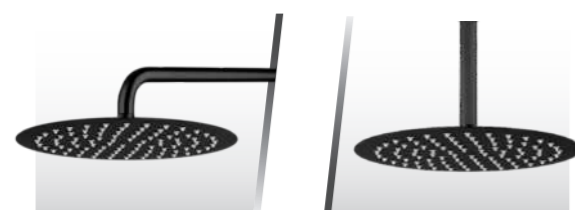

REF. 68468

REF. 68469





Serie
QUO B
CROMO

ACABADO
FINISH



Cromo
Chrome



Marmol blanco
White marble



REF. 68476 Ø 26

MONOMANDO LAVABO ALTO
High lever wash-basin mixer
Mitigeur lavabo haut
Monocomando lavatório alto

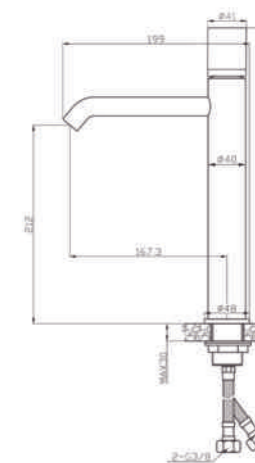

REF. 68471 Ø 26

MONOMANDO LAVABO
Single lever wash-basin mixer
Mitigeur lavabo
Monocomando lavatório

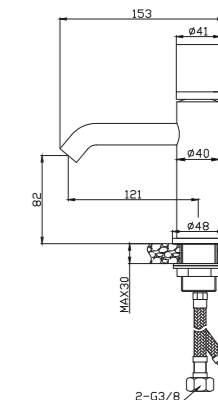

REF. 68472 Ø 26

MONOMANDO BIDÉ
Single lever bidet mixer
Mitigeur bidet
Monocomando bidé

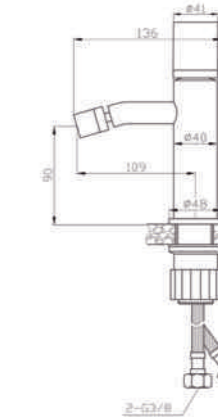

REF. 68477 Ø 35

MONOMANDO EMPOTRADO LAVABO
Built-in single lever washbasin mixer
Mitigeur lavabo à encastrer
Monocomando lavatorio embutida

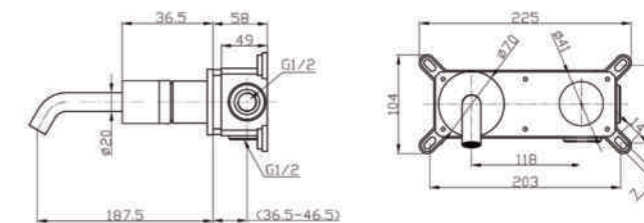

* Instalación con cajetín empotrado
Installation with recessed box
Installation avec boîtier d'encastrement
Instalação com caixa embutida

COMBINA CON...
MATCHES WELL WITH...



SYN

pg. 140



CESTAS LIME

pg. 146



CLIC-GLAC

pg. 156

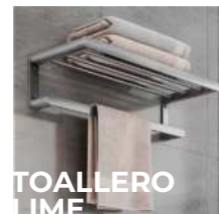

TOALLERO
LIME

pg. 144

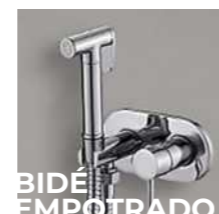

BIDÉ
EMPOTRADO

pg. 133



SET EMPOTRADO DUCHA MONOMANDO Ø35

AISI 304

- S ROCIADOR
- L Sprayer
- I Pulvérisateur
- M Pulverizador

- FLEJO AISI 304
- Shower hose
- Flexible douche
- Mangueira chuveiro

- MANGO TUBI
- Shower handle
- Douchette
- Chuveiro



REF. 68478



REF. 68479

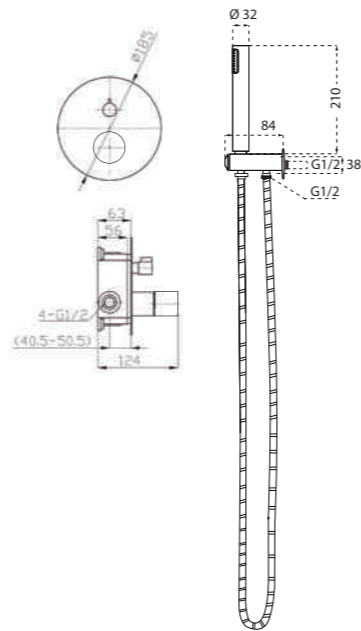
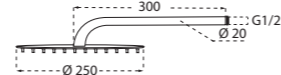



Serie
QUON
CROMO

ACABADO
FINISH



Cromo
Chrome

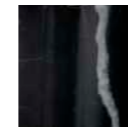

Marmol negro
Black marble



REF. 68486 Ø 26

MONOMANDO LAVABO ALTO
High lever wash-basin mixer
Mitigeur lavabo haut
Monocomando lavatório alto

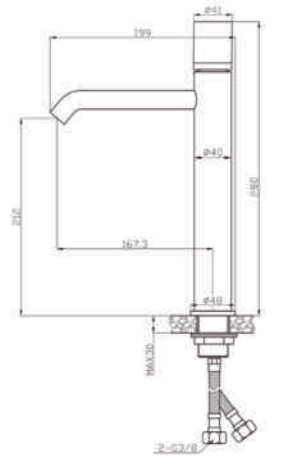

REF. 68481 Ø 26

MONOMANDO LAVABO
Single lever wash-basin mixer
Mitigeur lavabo
Monocomando lavatório

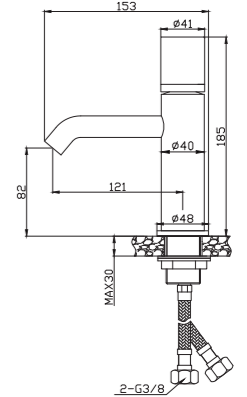

REF. 68482 Ø 26

MONOMANDO BIDÉ
Single lever bidet mixer
Mitigeur bidet
Monocomando bidé

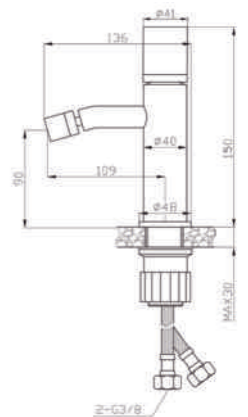

REF. 68487 Ø 35

MONOMANDO EMPOTRADO LAVABO
Built-in single lever washbasin mixer
Mitigeur lavabo à encastrer
Monocomando lavatorio embutida

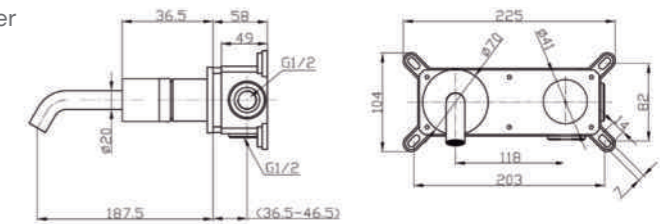

* Instalación con cajetín empotrado
Installation with recessed box
Installation avec boîtier d'encastrement
Intalação com caixa embutida

COMBINA CON...
MATCHES WELL WITH...



SYN BLACK
pg. 142



CESTAS LIME
pg. 146



SIFONES
pg. 158

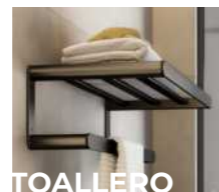

TOALLERO
LIME
pg. 144



BIDÉ
EMPOTRADO
pg. 133



SET EMPOTRADO DUCHA MONOMANDO Ø35

AISI 304

- S ROCIADOR
- L Sprayer
- I Pulvérisateur
- M Pulverizador

- FLEJO AISI 304
- Shower hose
- Flexible douche
- Mangueira chuveiro

- MANGO TUBI
- Shower handle
- Douchette
- Chuveiro



REF. 68488

REF. 68489





Serie
PLATINUM

ACABADO
FINISH



Cromo
Chrome



REF. 68496 Ø 26

MONOMANDO LAVABO ALTO
High lever wash-basin mixer
Mitigeur lavabo haut
Monocomando lavatório alto

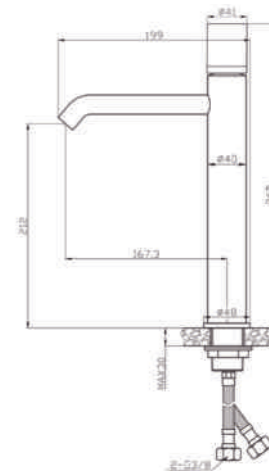

REF. 68491 Ø 26

MONOMANDO LAVABO
Single lever wash-basin mixer
Mitigeur lavabo
Monocomando lavatório

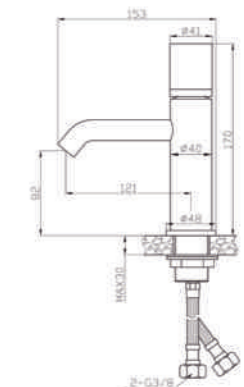

REF. 68492 Ø 26

MONOMANDO BIDÉ
Single lever bidet mixer
Mitigeur bidet
Monocomando bidé

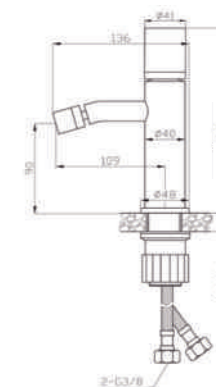

REF. 68497 Ø 35

MONOMANDO EMPOTRADO LAVABO
Built-in single lever washbasin mixer
Mitigeur lavabo à encastrer
Monocomando lavatorio embutida

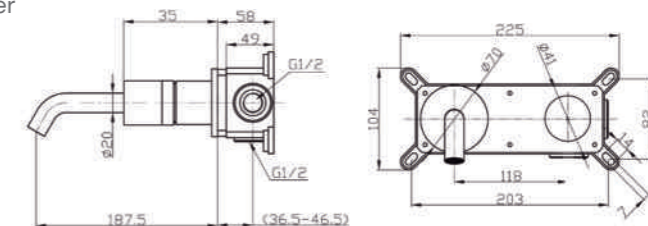

* Instalación con cajetín empotrado
Installation with recessed box
Installation avec boîtier d'encastrement
Instalação com caixa embutida

COMBINA CON...
MATCHES WELL WITH...



SYN

pg. 140



CESTAS LIME

pg. 146



CLIC-CLAC

pg. 156

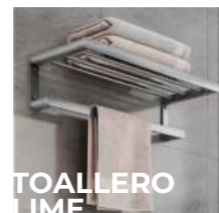

TOALLERO
LIME

pg. 144



BIDÉ
EMPOTRADO

pg. 133



SET EMPOTRADO DUCHA MONOMANDO Ø35

AISI 304



S ROCIADOR
L Sprayer
I Pulvérisateur
M Pulverizador

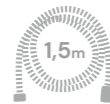

FLEJO AISI 304
Shower hose
Flexible douche
Mangueira chuveiro



MANGO TUBI
Shower handle
Douchette
Chuveiro

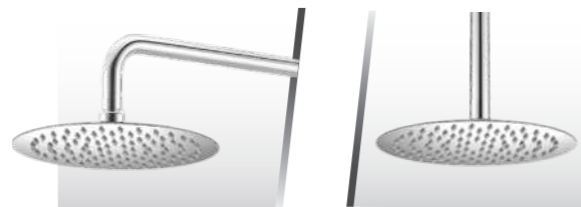

REF. 68498

REF. 68499

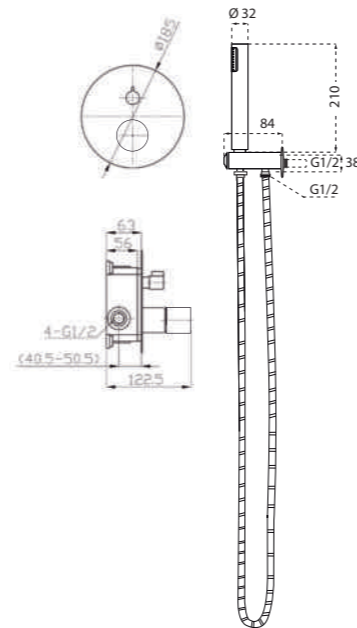
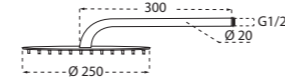

COLUMNA DUCHA MONOMANDO Ø 35

AISI 304



S ROCIADOR
L Sprayer
I Pulvérisateur
M Pulverizador

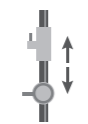

REGULABLE EN ALTURA
Height adjustable
Réglable en hauteur
Ajustável em altura



FLEJO AISI 304
Shower hose
Flexible douche
Mangueira chuveiro

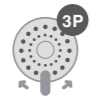

MANGO ERA
Shower handle
Douchette
Chuveiro



REF. 68490

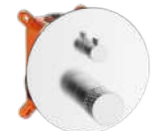
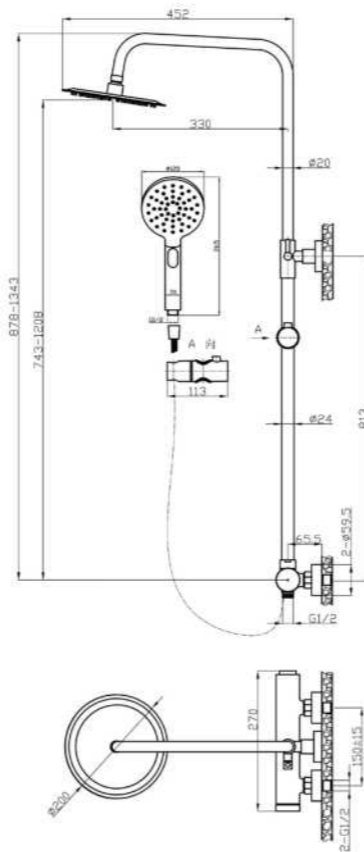

MK push



INVERSOR / INVERTER





Serie
PRESS

COMBINA CON...
MATCHES WELL WITH...



REF. 68601 Ø 26

MONOMANDO LAVABO
Single lever wash-basin mixer
Mitigeur lavabo
Monocomando lavatório

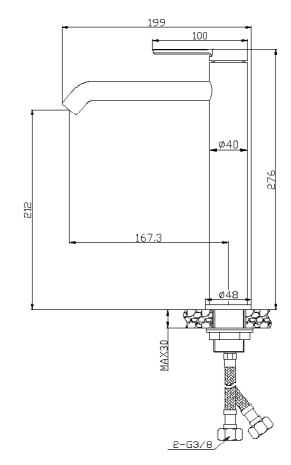

REF. 68602 Ø 26

MONOMANDO BIDE
Single lever bidet mixer
Mitigeur bidet
Monocomando bidé

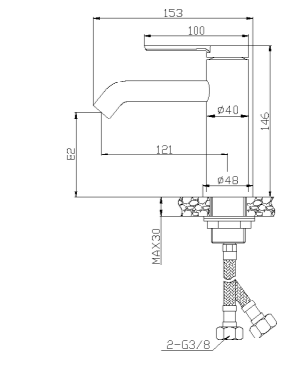

COLUMNA DUCHA MONOMANDO Ø 35

- S ROCIADOR
- L Sprayer
- I Pulvérisateur
- M Pulverizador

- REGULABLE EN ALTURA
- Height adjustable
- Réglable en hauteur
- Ajustável em altura

- FLEXP AISI 304
- Shower hose
- Flexible douche
- Manguera chuveiro

- MANGO ERA
- Shower handle
- Douchette
- Chuveiro



REF. 68600

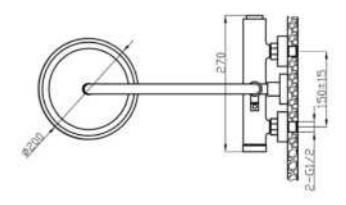
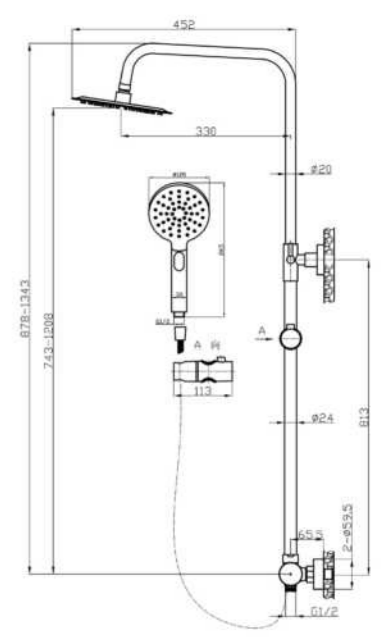

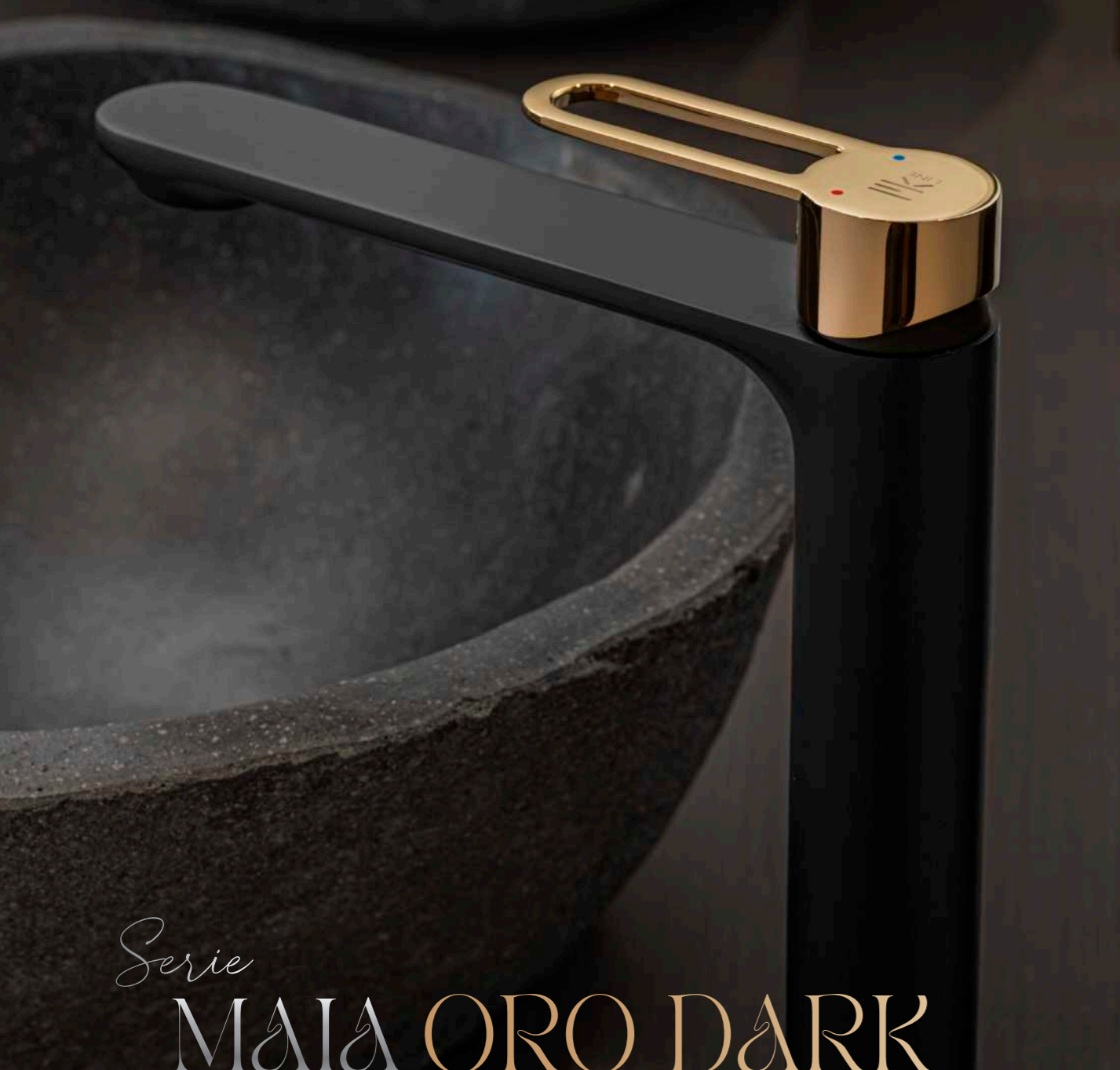

Serie
MAIA ORO DARK

BLACK

COMBINA CON...
MATCHES WELL WITH...



DECUA BLACK



CESTAS LIME



CLIC-CLAC

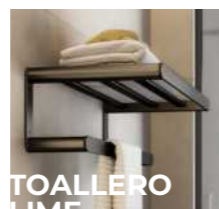

TOALLERO
LIME



ESCOBILLERO
DUAL

ACABADO
FINISH



Negro mate
Matt black



Oro dark
Dark gold



ACABADO / FINISH
Oro dark
Dark gold



REF. 68426

Ø 26

MONOMANDO LAVABO ALTO
High lever wash-basin mixer
Mitigeur lavabo haut
Monocomando lavatório alto

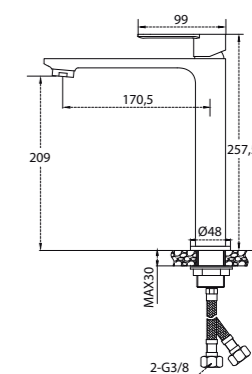

REF. 68421

Ø 26

MONOMANDO LAVABO
Single lever wash-basin mixer
Mitigeur lavabo
Monocomando lavatório

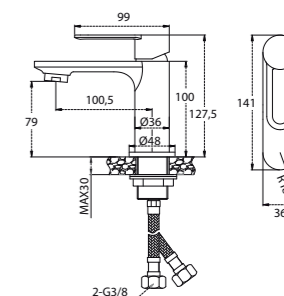

REF. 68422

Ø 26

MONOMANDO BIDÉ
Single lever bidet mixer
Mitigeur bidet
Monocomando bidé

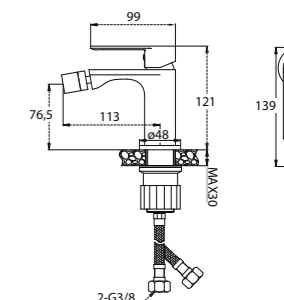

REF. 68425

Ø 25

MONOMANDO FREGADERA
Single lever sink mixer
Mitigeur évier
Monocomando cozinha

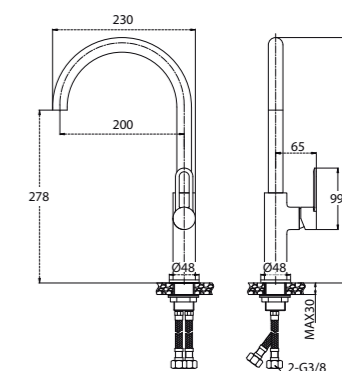



REF. 68423 Ø 30

- MONOMANDO BAÑO CON KIT**
- Single lever bath mixer
- Mitigreur baignoire
- Monocomando banho

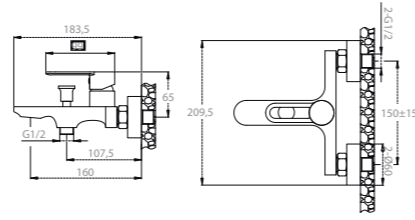

REF. 68424 Ø 30

- MONOMANDO DUCHA CON KIT**
- Single lever shower mixer
- Mitigreur douche
- Monocomando duche

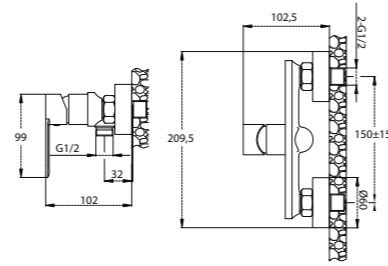

SET EMPOTRADO DUCHA MONOMANDO Ø35

AISI 304

- S ROCIADOR**
- L Sprayer
- I Pulvérisateur
- M Pulverizador

- FLEXO AISI 304**
- Shower hose
- Flexible douche
- Mangueira chuveiro

- MANGO TUBI ORO DARK**
- Shower handle
- Douchette
- Chuveiro



REF. 68428



REF. 68429



COLUMNA DUCHA MONOMANDO Ø 35

AISI 304

- S ROCIADOR**
- L Sprayer
- I Pulvérisateur
- M Pulverizador

- REGULABLE EN ALTURA**
- Height adjustable
- Réglable en hauteur
- Ajustável em altura

- FLEXO AISI 304**
- Shower hose
- Flexible douche
- Mangueira chuveiro

- MANGO ERA**
- Shower handle
- Douchette
- Chuveiro

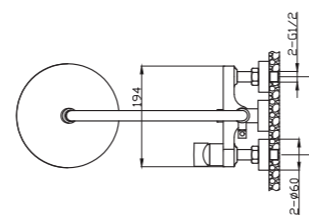
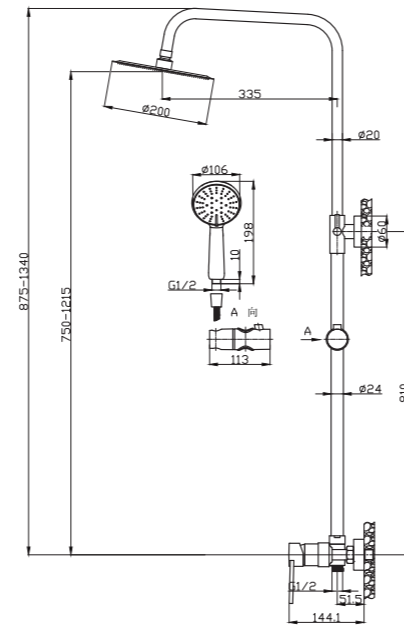

REF. 68420



REF. 68420-BA

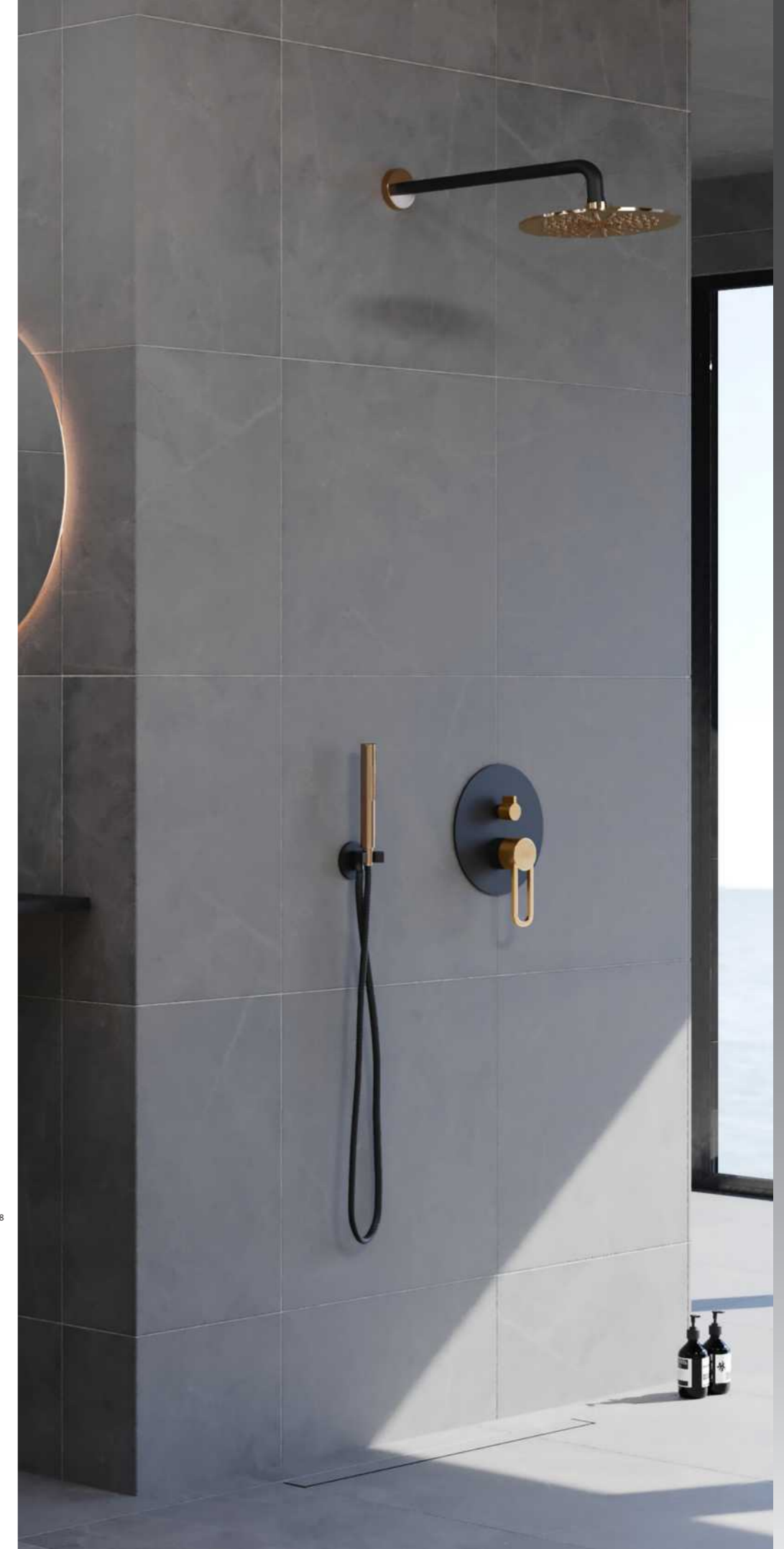

Serie MAIA ORO DARK



Serie
MAIA

ACABADO
FINISH



Cromo
Chrome



REF. 68146

Ø 26

MONOMANDO LAVABO ALTO

High lever wash-basin mixer
Mitigeur lavabo haut
Monocomando lavatório alto

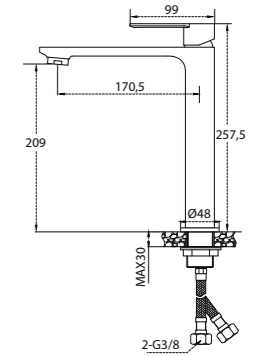

REF. 68141

Ø 26

MONOMANDO LAVABO

Single lever wash-basin mixer
Mitigeur lavabo
Monocomando lavatório

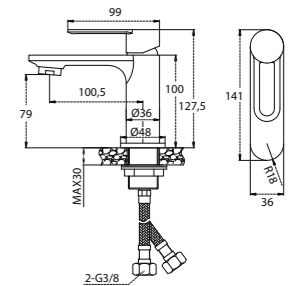

REF. 68142

Ø 26

MONOMANDO BIDÉ

Single lever bidet mixer
Mitigeur bidet
Monocomando bidé

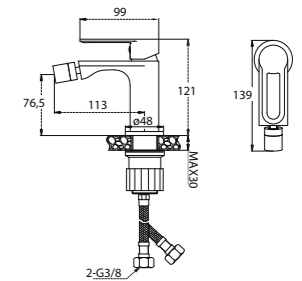

REF. 68145

Ø 25

MONOMANDO FREGADERA

Single lever sink mixer
Mitigeur évier
Monocomando cozinha

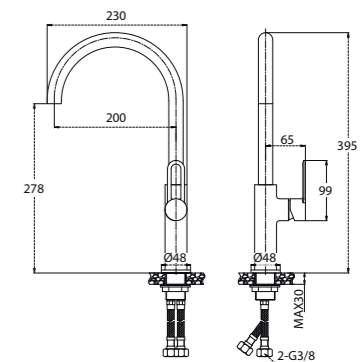

COMBINA CON...
MATCHES WELL WITH...



DECUA

pg. 137



CESTAS LIME

pg. 146



SIFONES

pg. 158

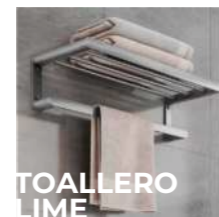

TOALLERO
LIME

pg. 144



BIDÉ
EMPOTRADO

pg. 133



SET EMPOTRADO DUCHA MONOMANDO Ø35

AISI 304

- S ROCIADOR
- L Sprayer
- I Pulvérisateur
- M Pulverizador

- FLEJO AISI 304
- Shower hose
- Flexible douche
- Manguera chuveiro

- MANGO TUBI
- Shower handle
- Douchette
- Chuveiro



REF. 68148



REF. 68149

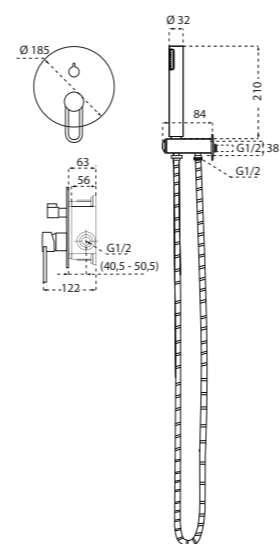
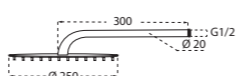

REF. 68143 Ø 30

- MONOMANDO BAÑO CON KIT
- Single lever bath mixer
- Mitigeur baignoire
- Monocomando banho

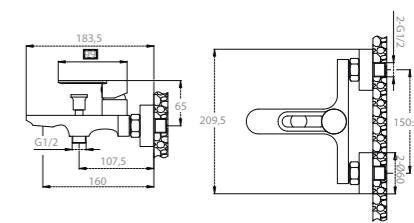

REF. 68144 Ø 30

- MONOMANDO DUCHA CON KIT
- Single lever shower mixer
- Mitigeur douche
- Monocomando duche

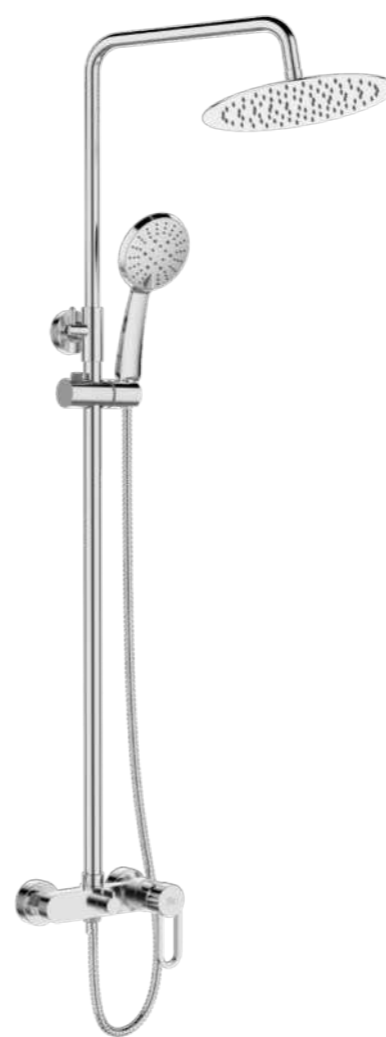
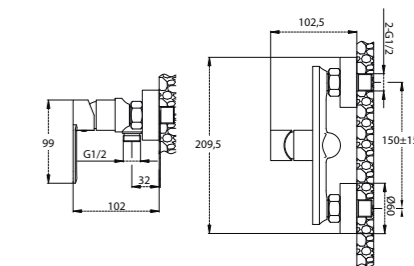

COLUMNA DUCHA MONOMANDO Ø 35

AISI 304

- S ROCIADOR
- L Sprayer
- I Pulvérisateur
- M Pulverizador

- REGULABLE EN ALTURA
- Height adjustable
- Réglable en hauteur
- Ajustável em altura

- FLEJO AISI 304
- Shower hose
- Flexible douche
- Manguera chuveiro

- MANGO OMEGA
- Shower handle
- Douchette
- Chuveiro

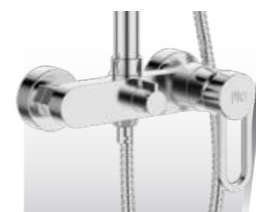

REF. 68140

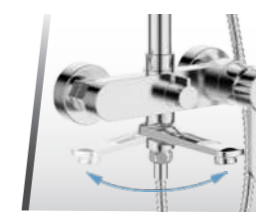

REF. 68140-BA

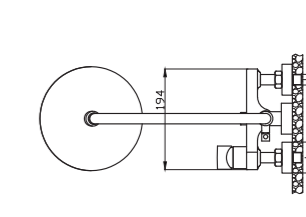
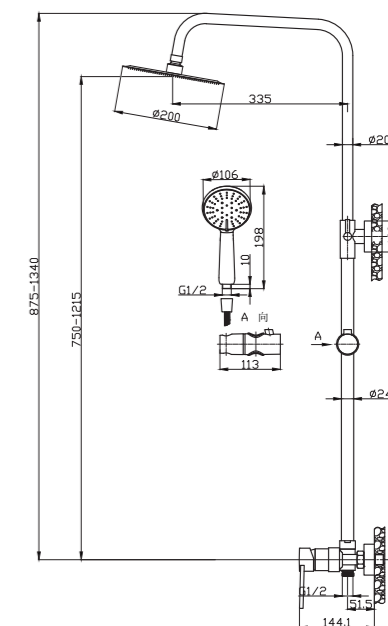



Serie
MAIA BLACK

ACABADO
FINISH



Negro mate
Matt black



REF. 68156

Ø 26

MONOMANDO LAVABO ALTO
High lever wash-basin mixer
Mitigeur lavabo haut
Monocomando lavatório alto

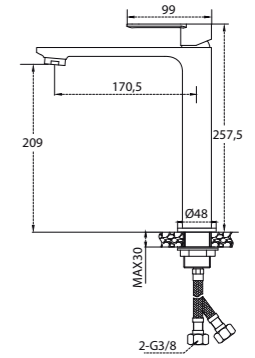

REF. 68151

Ø 26

MONOMANDO LAVABO
Single lever wash-basin mixer
Mitigeur lavabo
Monocomando lavatório

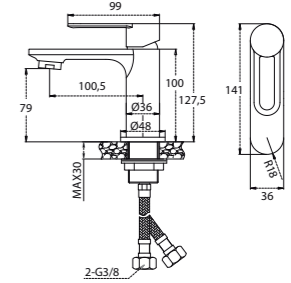

REF. 68152

Ø 26

MONOMANDO BIDÉ
Single lever bidet mixer
Mitigeur bidet
Monocomando bidé

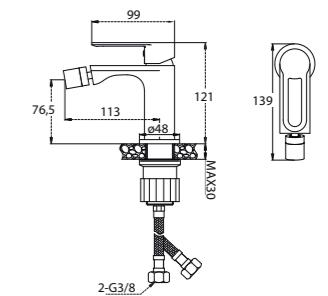

REF. 68155

Ø 25

MONOMANDO FREGADERA
Single lever sink mixer
Mitigeur évier
Monocomando cozinha

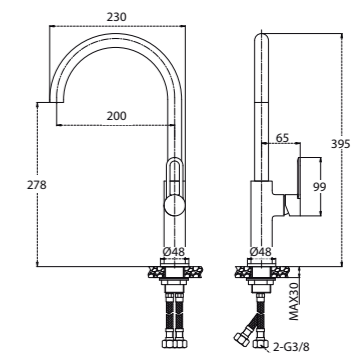

COMBINA CON...
MATCHES WELL WITH...



DECUA BLACK

pg. 138



CESTAS LIME

pg. 146



SIFONES

pg. 158

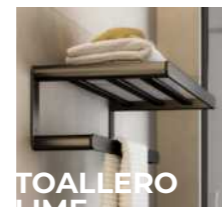

TOALLERO
LIME

pg. 144

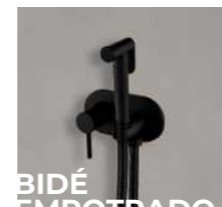

BIDÉ
EMPOTRADO

pg. 133



SET EMPOTRADO DUCHA MONOMANDO Ø35

AISI 304

- S** ROCIADOR
- L** Sprayer
- I** Pulvérisateur
- M** Pulverizador

- FLEXO AISI 304**
- Shower hose
- Flexible douche
- Mangueira chuveiro

- MANGO TUBI BLACK**
- Shower handle
- Douchette
- Chuveiro



REF. 68158



REF. 68159

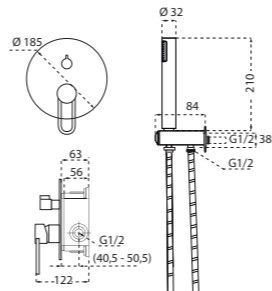
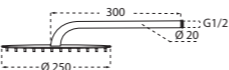

REF. 68153

Ø 30

- MONOMANDO BAÑO CON KIT**
- Single lever bath mixer
- Mitigeur baignoire
- Monocomando banho

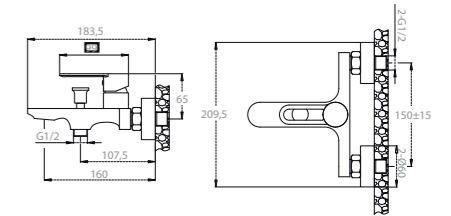

REF. 68154

Ø 30

- MONOMANDO DUCHA CON KIT**
- Single lever shower mixer
- Mitigeur douche
- Monocomando duche

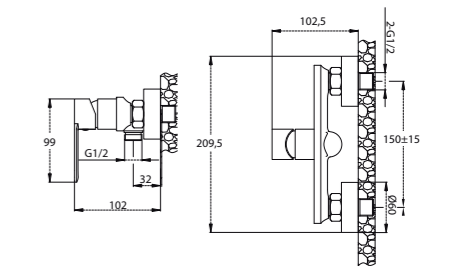

COLUMNA DUCHA MONOMANDO

Ø 35

AISI 304

- S** ROCIADOR
- L** Sprayer
- I** Pulvérisateur
- M** Pulverizador

- REGULABLE EN ALTURA**
- Height adjustable
- Réglable en hauteur
- Ajustável em altura

- FLEXO AISI 304**
- Shower hose
- Flexible douche
- Mangueira chuveiro

- MANGO BANI BLACK**
- Shower handle
- Douchette
- Chuveiro



REF. 68150



REF. 68150-BA

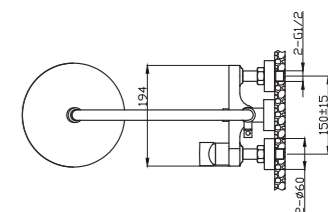
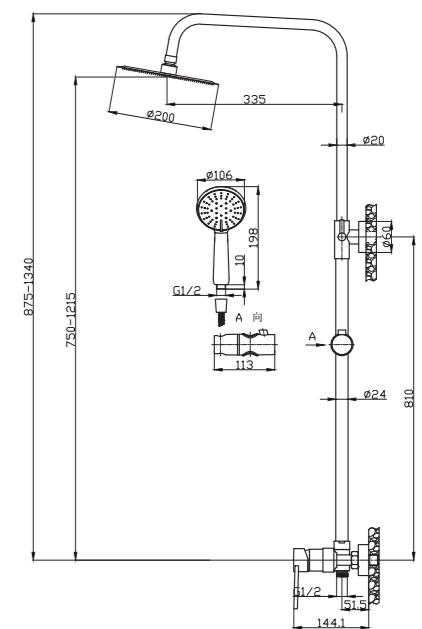



Serie
SVELTA FULL BLACK

ACABADO
FINISH



Negro mate
Matt black



Efecto granito
Granite effect



REF. 68406

Ø 26

MONOMANDO LAVABO ALTO
High lever wash-basin mixer
Mitigeur lavabo haut
Monocomando lavatório alto

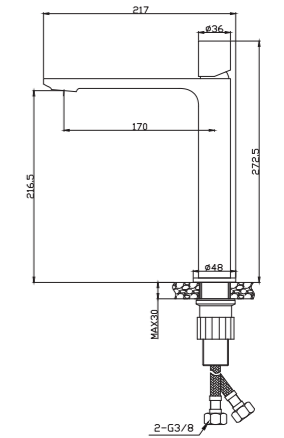

REF. 68401

Ø 26

MONOMANDO LAVABO
Single lever wash-basin mixer
Mitigeur lavabo
Monocomando lavatório

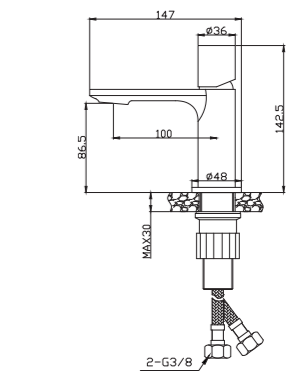

REF. 68402

Ø 26

MONOMANDO BIDÉ
Single lever bidet mixer
Mitigeur bidet
Monocomando bidé

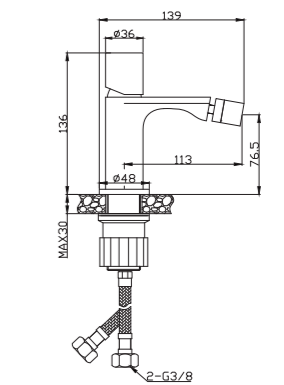

REF. 68405

Ø 25

MONOMANDO FREGADERA
Single lever sink mixer
Mitigeur évier
Monocomando cozinha

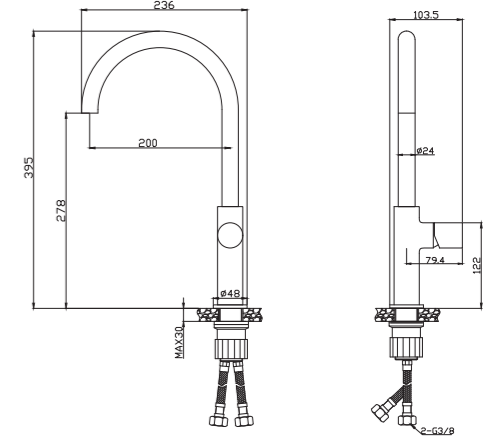

COMBINA CON...
MATCHES WELL WITH...



SYN BLACK

pg. 142



CESTAS LIME

pg. 146



CLIC-CLAC

pg. 156

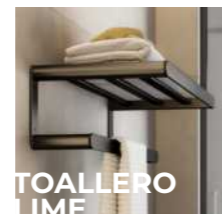

TOALLERO
LIME

pg. 144

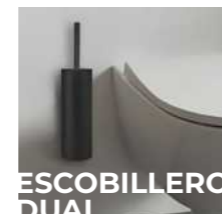

ESCOBILLERO
DUAL

pg. 150



REF. 68403

Ø 30

- MONOMANDO BAÑO CON KIT**
 Single lever bath mixer
 Mitigeur baignoire
 Monocomando banho

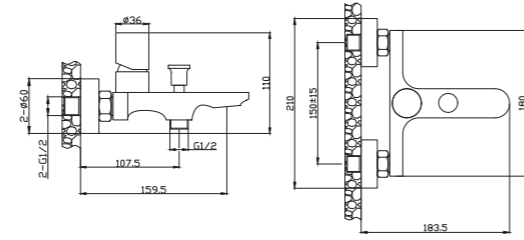

COLUMNA DUCHA MONOMANDO

Ø 35

AISI 304

- S ROCIADOR**
 L Sprayer
 I Pulvérisateur
 M Pulverizador

- REGULABLE EN ALTURA**
 Height adjustable
 Réglable en hauteur
 Ajustável em altura

- FLEXO AISI 304**
 Shower hose
 Flexible douche
 Mangueira chuveiro

- MANGO BANI BLACK**
 Shower handle
 Douchette
 Chuveiro



REF. 68400



REF. 68400-BA

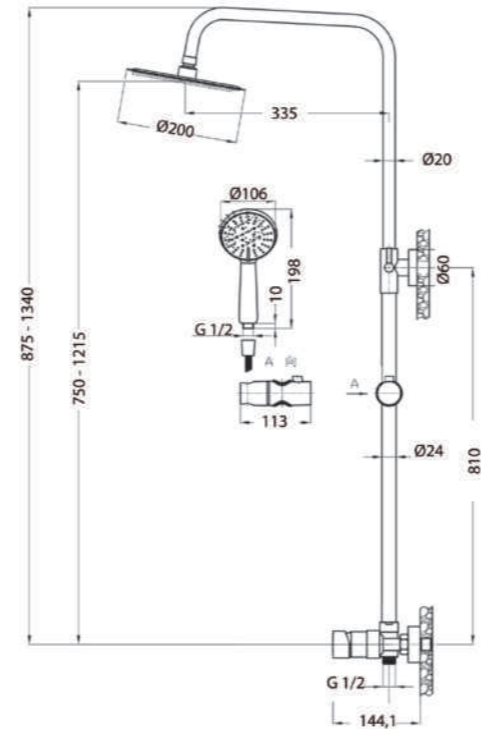

SET EMPOTRADO DUCHA MONOMANDO

Ø35

AISI 304

- S ROCIADOR**
 L Sprayer
 I Pulvérisateur
 M Pulverizador

- FLEXO AISI 304**
 Shower hose
 Flexible douche
 Mangueira chuveiro

- MANGO TUBI**
 Shower handle
 Douchette
 Chuveiro



REF. 68408



REF. 68409

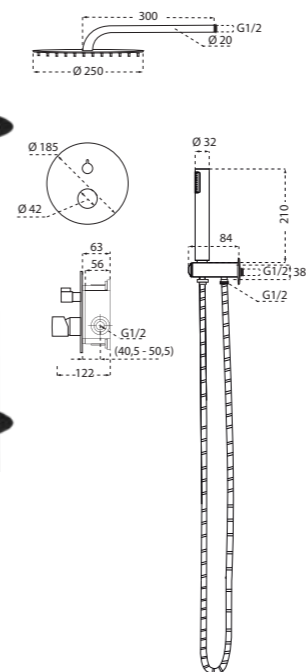



Serie
SVELTA

ACABADO
FINISH



Cromo
Chrome



Efecto granito
Granite effect



REF. 68186

Ø 26

MONOMANDO LAVABO ALTO

High lever wash-basin mixer
Mitigeur lavabo haut
Monocomando lavatório alto

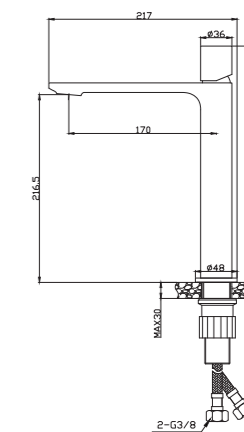

REF. 68181

Ø 26

MONOMANDO LAVABO

Single lever wash-basin mixer
Mitigeur lavabo
Monocomando lavatório

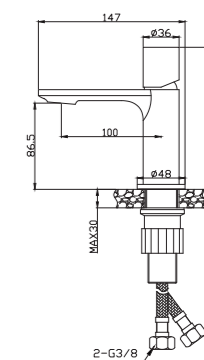

REF. 68182

Ø 26

MONOMANDO BIDÉ

Single lever bidet mixer
Mitigeur bidet
Monocomando bidé

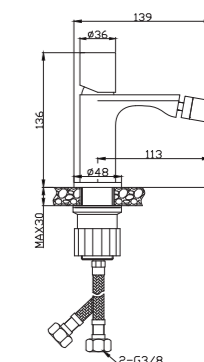

REF. 68185

Ø 25

MONOMANDO FREGADERA

Single lever sink mixer
Mitigeur évier
Monocomando cozinha

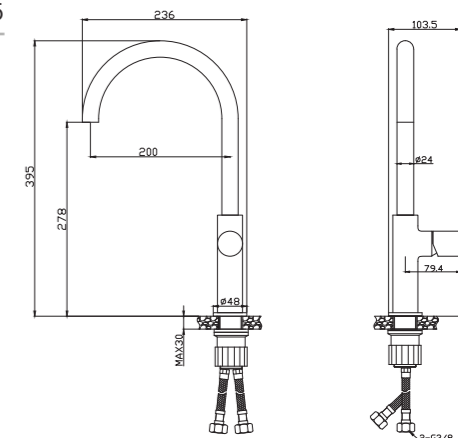

COMBINA CON...
MATCHES WELL WITH...



SYN

pg. 140



CESTAS LIME

pg. 146



CLIC-CLAC

pg. 156

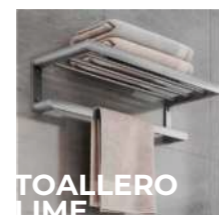

TOALLERO
LIME

pg. 144

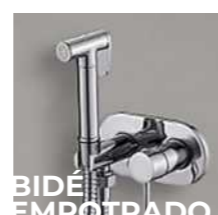

BIDÉ
EMPOTRADO

pg. 133



REF. 68183

Ø 30

- MONOMANDO BAÑO CON KIT**
 Single lever bath mixer
 Mitigeur baignoire
 Monocomando banho

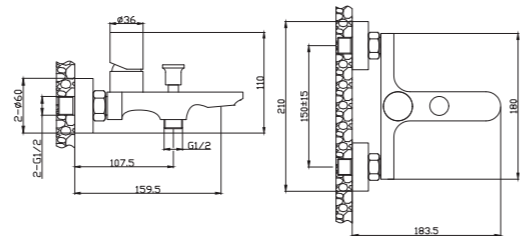

COLUMNA DUCHA MONOMANDO

Ø 35

- S** ROCIADOR
L Sprayer
I Pulvérisateur
M Pulverizador

- REGULABLE EN ALTURA**
 Height adjustable
 Réglable en hauteur
 Ajustável em altura

- FLEXO AISI 304**
 Shower hose
 Flexible douche
 Mangueira chuveiro

- MANGO OMEGA**
 Shower handle
 Douchette
 Chuveiro

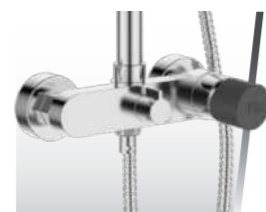

REF. 68180

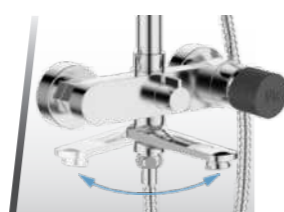

REF. 68180-BA

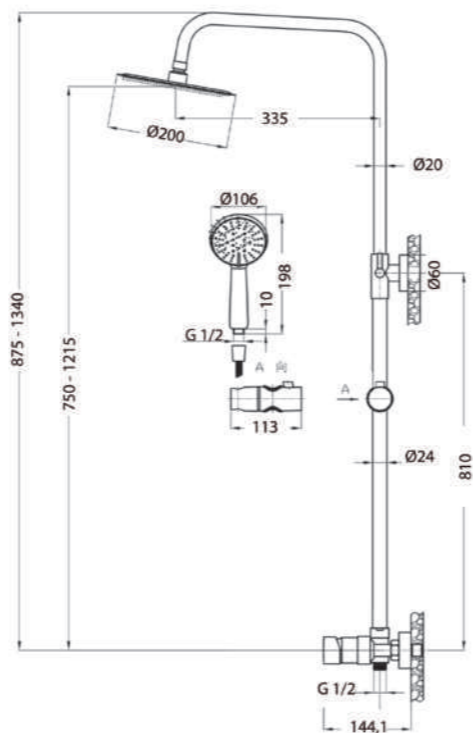

SET EMPOTRADO DUCHA MONOMANDO Ø35

AISI 304

- S** ROCIADOR
L Sprayer
I Pulvérisateur
M Pulverizador

- FLEXO AISI 304**
 Shower hose
 Flexible douche
 Mangueira chuveiro

- MANGO TUBI**
 Shower handle
 Douchette
 Chuveiro

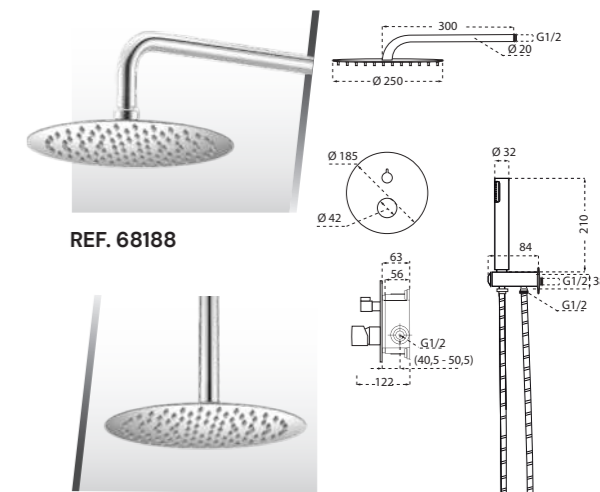

REF. 68188

REF. 68189



Serie
SVELTA BLACK

ACABADO FINISH



Negro mate
Matt black

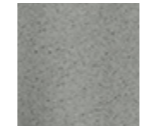

Efecto granito
Granite effect



REF. 68196

Ø 26

MONOMANDO LAVABO ALTO
High lever wash-basin mixer
Mitigeur lavabo haut
Monocomando lavatório alto

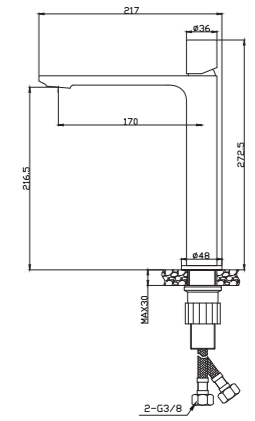

REF. 68191

Ø 26

MONOMANDO LAVABO
Single lever wash-basin mixer
Mitigeur lavabo
Monocomando lavatório

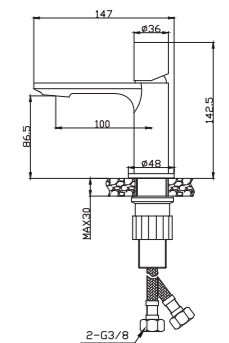

REF. 68192

Ø 26

MONOMANDO BIDÉ
Single lever bidet mixer
Mitigeur bidet
Monocomando bidé

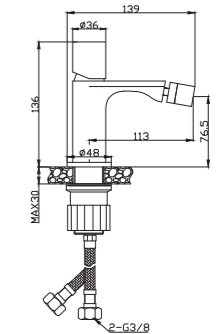

REF. 68195

Ø 25

MONOMANDO FREGADERA
Single lever sink mixer
Mitigeur évier
Monocomando cozinha

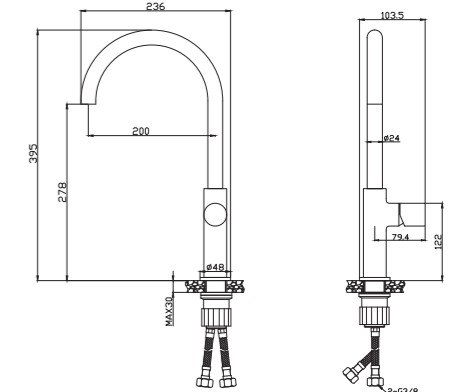

**COMBINA CON...
MATCHES WELL WITH...**



SYN BLACK

pg. 142



CESTAS LIME

pg. 146



SIFONES

pg. 158

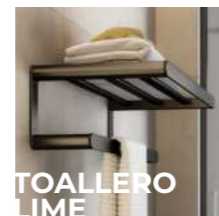

**TOALLERO
LIME**

pg. 144

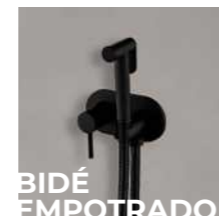

**BIDÉ
EMPOTRADO**

pg. 133



REF. 68193

Ø 30



MONOMANDO BAÑO CON KIT
Single lever bath mixer
Mitigeur baignoire
Monocomando banho

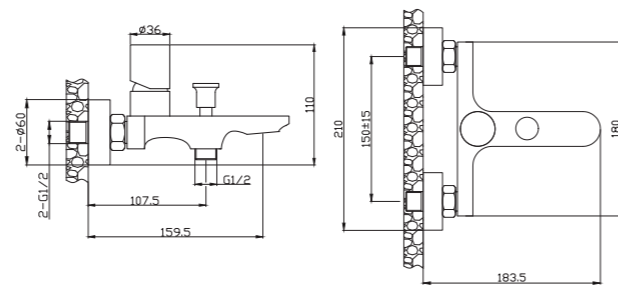

COLUMNA DUCHA MONOMANDO

Ø 35



S ROCIADOR
L Sprayer
I Pulvérisateur
M Pulverizador

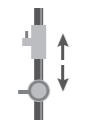

REGULABLE EN ALTURA
Height adjustable
Réglable en hauteur
Ajustável em altura



FLEJO AISI 304
Shower hose
Flexible douche
Mangueira chuveiro

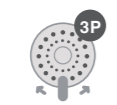

MANGO BANI BLACK
Shower handle
Douchette
Chuveiro

AISI 304

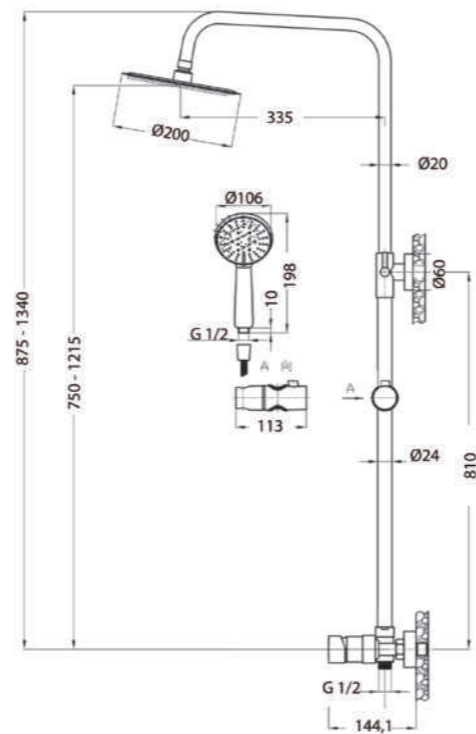

REF. 68190

REF. 68190-BA

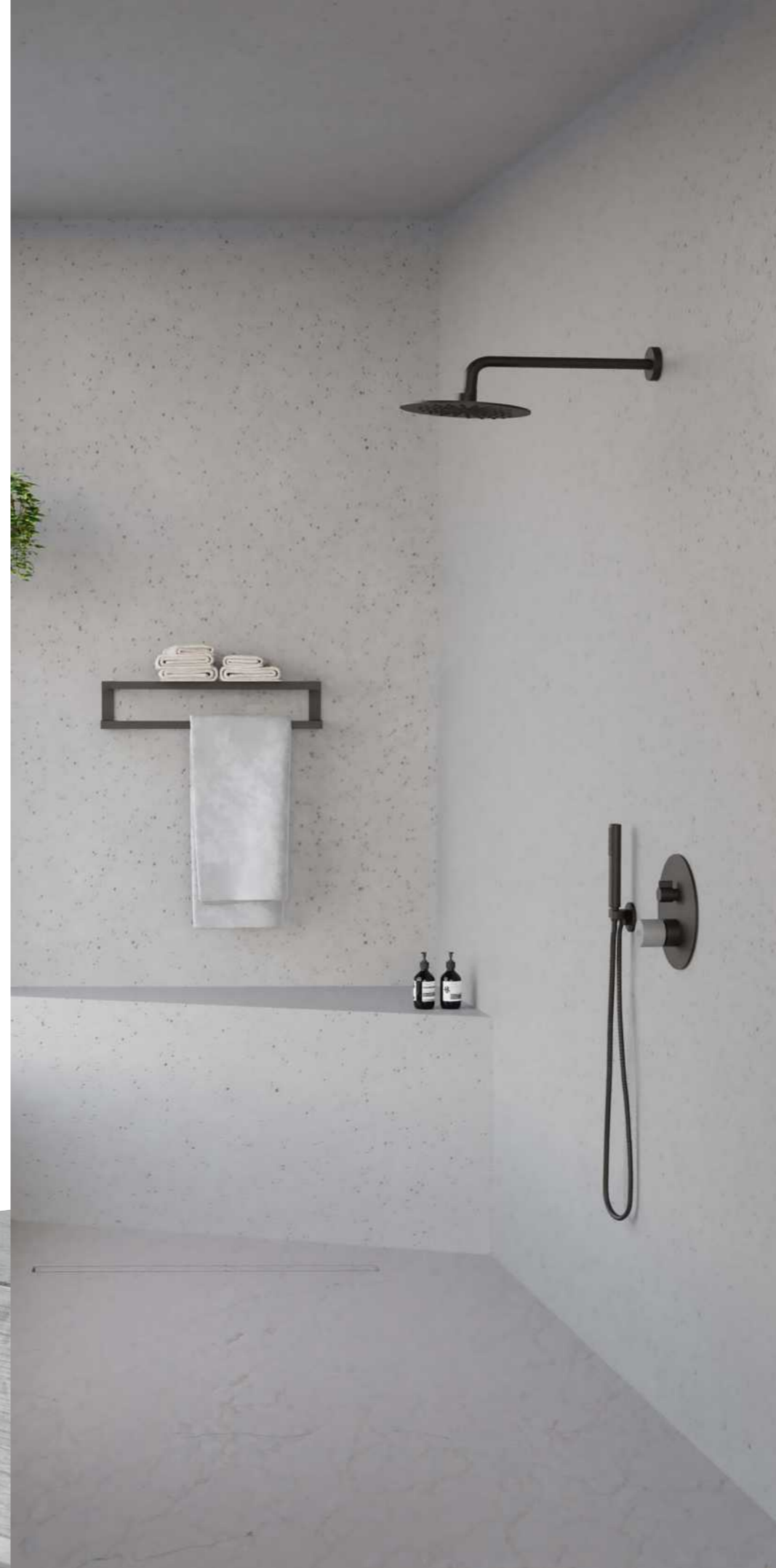

SET EMPOTRADO DUCHA MONOMANDO Ø35

AISI 304



S ROCIADOR
L Sprayer
I Pulvérisateur
M Pulverizador



FLEJO AISI 304
Shower hose
Flexible douche
Mangueira chuveiro



MANGO TUBI BLACK
Shower handle
Douchette
Chuveiro



REF. 68198

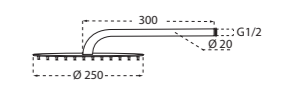

REF. 68199

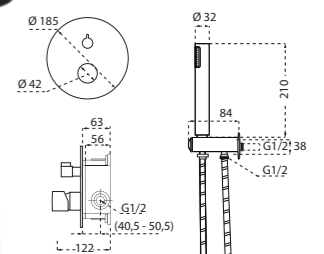



Serie
VEGA

ACABADO
FINISH



Cromo
Chrome



REF. 68136

Ø 26

MONOMANDO LAVABO ALTO
High lever wash-basin mixer
Mitigeur lavabo haut
Monocomando lavatório alto

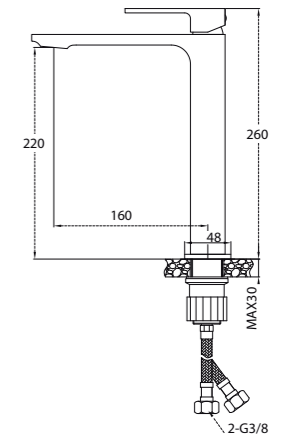

REF. 68131

Ø 26

MONOMANDO LAVABO
Single lever wash-basin mixer
Mitigeur lavabo
Monocomando lavatório

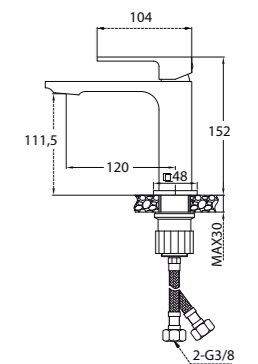

REF. 68132

Ø 26

MONOMANDO BIDÉ
Single lever bidet mixer
Mitigeur bidet
Monocomando bidé

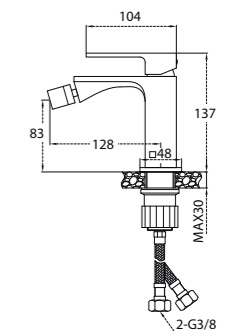

REF. 68135

Ø 25

MONOMANDO FREGADERA
Single lever sink mixer
Mitigeur évier
Monocomando cozinha

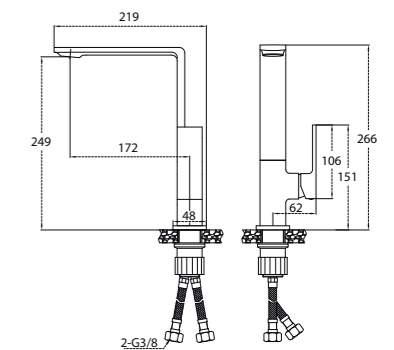

COMBINA CON...
MATCHES WELL WITH...



DECUA

pg. 136



CESTAS LIME

pg. 146



CLIC-CLAC

pg. 156

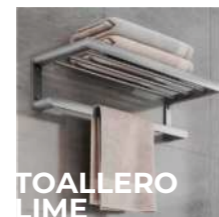

TOALLERO
LIME

pg. 144



BIDÉ
EMPOTRADO

pg. 133



SET EMPOTRADO DUCHA MONOMANDO Ø35

AISI 304

- S** ROCIADOR
- L** Sprayer
- I** Pulvérisateur
- M** Pulverizador

- FLEXO AISI 304**
- Shower hose
- Flexible douche
- Manguera chuveiro

- MANGO NERVION**
- Shower handle
- Douchette
- Chuveiro

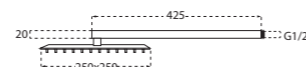

REF. 68138

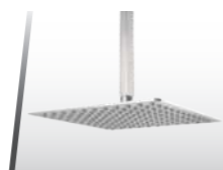

REF. 68139

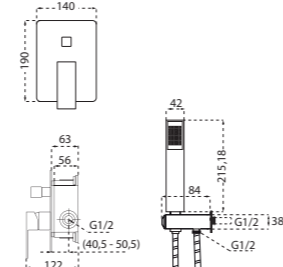

REF. 68133

Ø 30

- MONOMANDO BAÑO CON KIT**
- Single lever bath mixer
- Mitigeur baignoire
- Monocomando banho

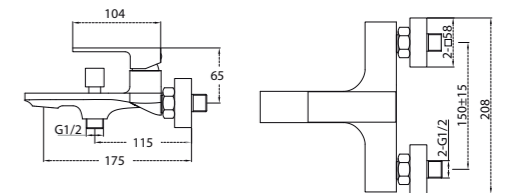

REF. 68134

Ø 30

- MONOMANDO DUCHA CON KIT**
- Single lever shower mixer
- Mitigeur douche
- Monocomando duche

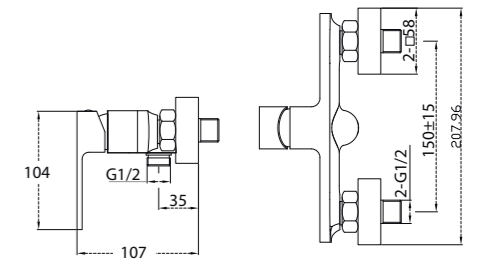

COLUMNA DUCHA MONOMANDO

Ø 35

AISI 304

- S** ROCIADOR
- L** Sprayer
- I** Pulvérisateur
- M** Pulverizador

- REGULABLE EN ALTURA**
- Height adjustable
- Réglable en hauteur
- Ajustável em altura

- FLEXO AISI 304**
- Shower hose
- Flexible douche
- Manguera chuveiro

- MANGO NERVION**
- Shower handle
- Douchette
- Chuveiro

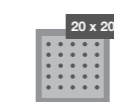

REF. 68130

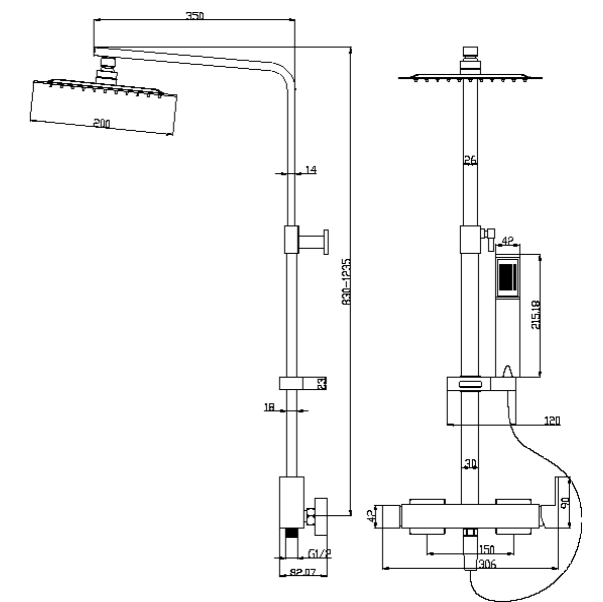



Serie
TENNA

ACABADO
FINISH



Cromo
Chrome



REF. 68091

Ø 35

MONOMANDO LAVABO

Single lever wash-basin mixer
Mitigeur lavabo
Monocomando lavatório

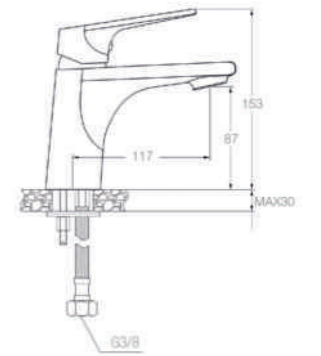

REF. 68092

Ø 35

MONOMANDO BIDÉ

Single lever bidet mixer
Mitigeur bidet
Monocomando bidé

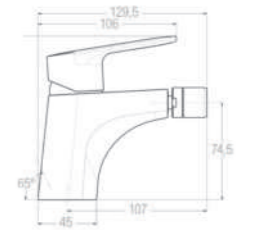

REF. 68095

Ø 35

MONOMANDO FREGADERA

Single lever sink mixer
Mitigeur évier
Monocomando cozinha

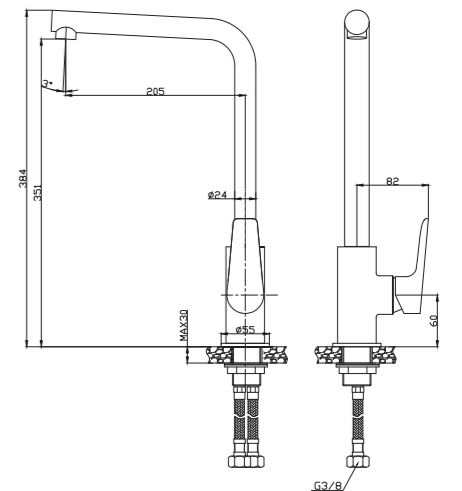

COMBINA CON...
MATCHES WELL WITH...



DECUA

pg. 137



CESTAS LIME

pg. 146



CLIC-CLAC

pg. 156

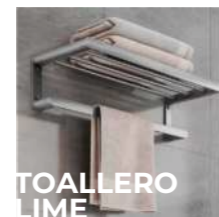

TOALLERO
LIME

pg. 144

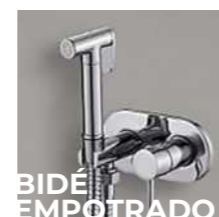

BIDÉ
EMPOTRADO

pg. 133





REF. 68093

Ø 35

- MONOMANDO BAÑO CON KIT**
 Single lever bath mixer
 Mitigeur baignoire
 Monocomando banho

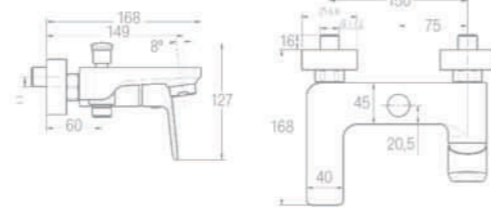

REF. 68094

Ø 35

- MONOMANDO DUCHA CON KIT**
 Single lever shower mixer
 Mitigeur douche
 Monocomando duche

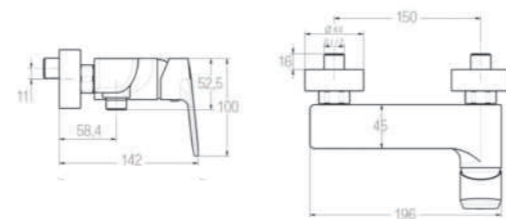

SET EMPOTRADO DUCHA MONOMANDO Ø35

AISI 304

- S** ROCIADOR
L Sprayer
I Pulvérisateur
M Pulverizador

- FLEJO AISI 304**
 Shower hose
 Flexible douche
 Mangueira chuveiro

- MANGO TUBI**
 Shower handle
 Douchette
 Chuveiro



REF. 68098

REF. 68099

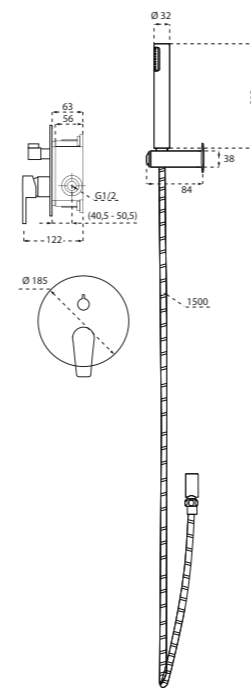
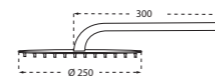

COLUMNA DUCHA MONOMANDO

Ø 35

AISI 304

- S** ROCIADOR
L Sprayer
I Pulvérisateur
M Pulverizador

- REGULABLE EN ALTURA**
 Height adjustable
 Réglable en hauteur
 Ajustável em altura

- FLEJO AISI 304**
 Shower hose
 Flexible douche
 Mangueira chuveiro

- MANGO EYRE**
 Shower handle
 Douchette
 Chuveiro

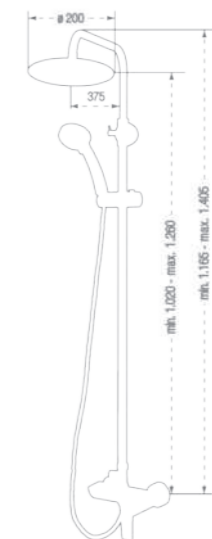

REF. 68090

ACABADO
FINISH



Cromo
Chrome



Serie
YUKON

COMBINA CON...
MATCHES WELL WITH...



DECUA

pg. 136



CESTAS LIME

pg. 146



SIFONES

pg. 158

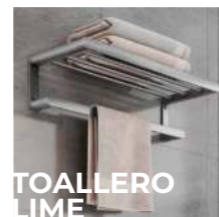

TOALLERO
LIME

pg. 144

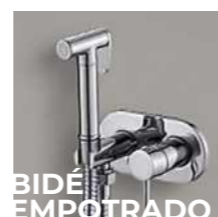

BIDÉ
EMPOTRADO

pg. 133



REF. 68161

Ø 40

MONOMANDO LAVABO

Single lever wash-basin mixer
Mitigeur lavabo
Monocomando lavatório

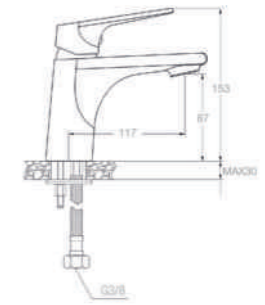

REF. 68162

Ø 40

MONOMANDO BIDÉ

Single lever bidet mixer
Mitigeur bidet
Monocomando bidé

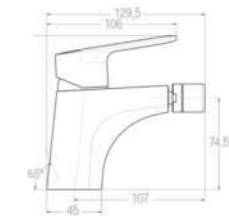

REF. 68163

Ø 40

MONOMANDO BAÑO CON KIT

Single lever bath mixer
Mitigeur baignoire
Monocomando banho

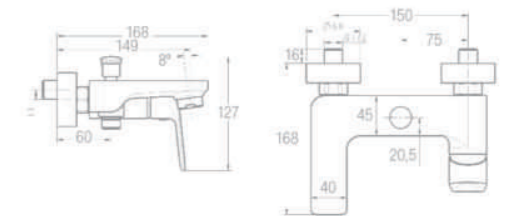

REF. 68164

Ø 40

MONOMANDO DUCHA CON KIT

Single lever shower mixer
Mitigeur douche
Monocomando duche

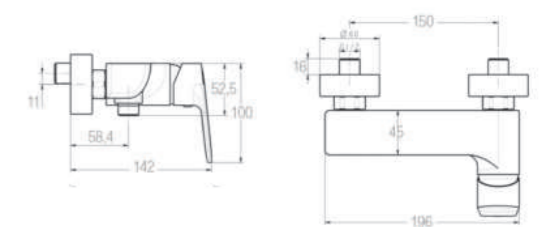

OTRAS COLUMNAS

OTHER SHOWER COLUMN MIXERS





Columna ducha
VOLTA BLACK



COLUMNA DUCHA MONOMANDO

Ø 35

AISI 304

- S ROCIADOR
- L Sprayer
- I Pulvérisateur
- M Pulverizador

- REGULABLE EN ALTURA
- Height adjustable
- Réglable en hauteur
- Ajustável em altura

- FLEXO 1,5 m
- Shower hose
- Flexible douche
- Manguera chuveiro

- MANGO BANI BLACK
- Shower handle
- Douchette
- Chuveiro



REF. 68063

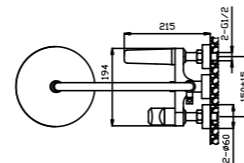
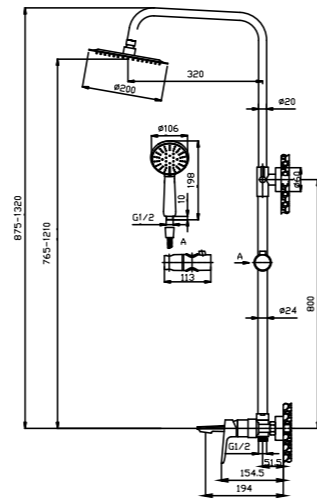

Columna ducha
SPACE

COLUMNA DUCHA MONOMANDO

Ø 35

AISI 304

- S ROCIADOR
- L Sprayer
- I Pulvérisateur
- M Pulverizador

- REGULABLE EN ALTURA
- Height adjustable
- Réglable en hauteur
- Ajustável em altura

- FLEXO 1,5 m
- Shower hose
- Flexible douche
- Manguera chuveiro

- MANGO NERVION
- Shower handle
- Douchette
- Chuveiro



REF. 68078

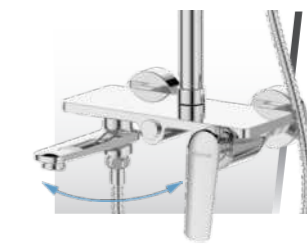

REF. 68079

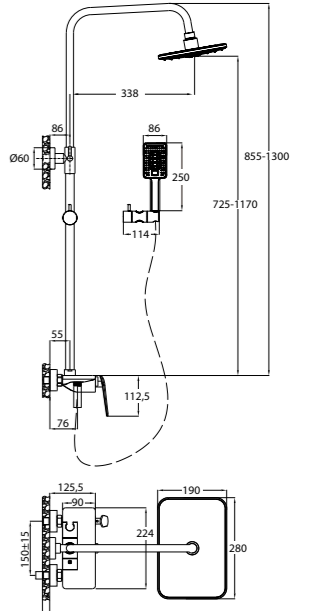



Columna ducha
SQ-77

COLUMNA DUCHA TERMOSTÁTICA

Ø 35

AISI 304

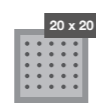

- S** ROCIADOR
- L** Sprayer
- I** Pulvérisateur
- M** Pulverizador

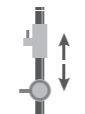

- REGULABLE EN ALTURA**
- Height adjustable
- Réglable en hauteur
- Ajustável em altura



- FLEXO 1,5 m**
- Shower hose
- Flexible douche
- Mangueira chuveiro



- MANGO NERVION**
- Shower handle
- Douchette
- Chuveiro



REF. 68077

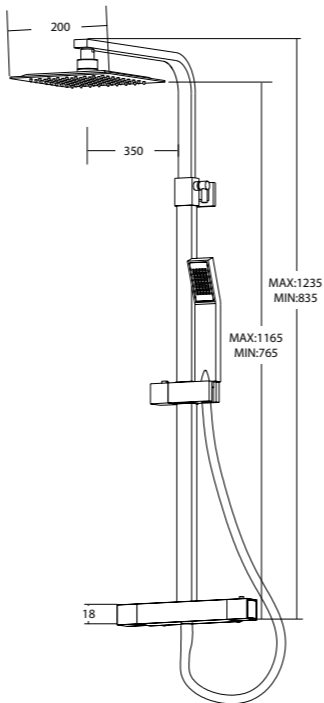

Columna ducha
VULKAN

COLUMNA DUCHA TERMOSTÁTICA

Ø 34

AISI 304



- S** ROCIADOR
- L** Sprayer
- I** Pulvérisateur
- M** Pulverizador

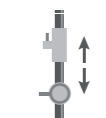

- REGULABLE EN ALTURA**
- Height adjustable
- Réglable en hauteur
- Ajustável em altura



- FLEXO 1,5 m**
- Shower hose
- Flexible douche
- Mangueira chuveiro



- MANGO BANI BLACK**
- Shower handle
- Douchette
- Chuveiro



REF. 68064

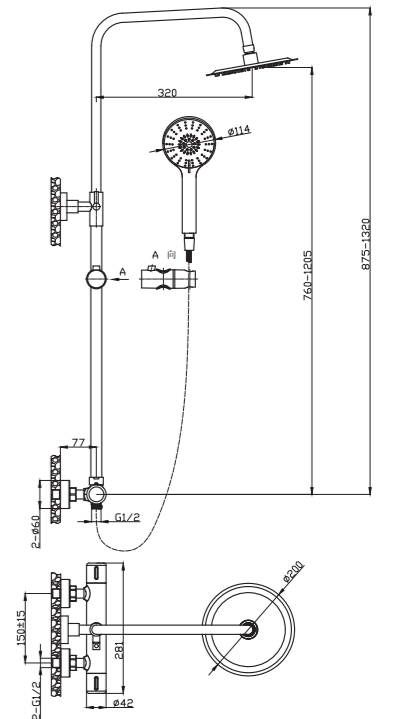



Columna ducha
MAXI-2



COLUMNA DUCHA TERMOSTÁTICA

Ø 34

AISI 304

- S ROCIADOR
- L Sprayer
- I Pulvérisateur
- M Pulverizador

- REGULABLE EN ALTURA
- Height adjustable
- Réglable en hauteur
- Ajustável em altura

- FLEXO 1,5 m
- Shower hose
- Flexible douche
- Mangueira chuveiro

- MANGO OMEGA
- Shower handle
- Douchette
- Chuveiro



REF. 68057

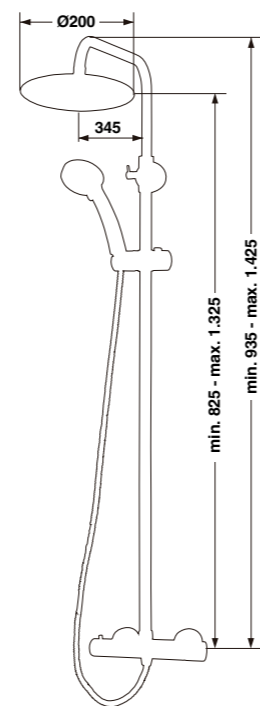

Columna ducha
NEW CENTURY

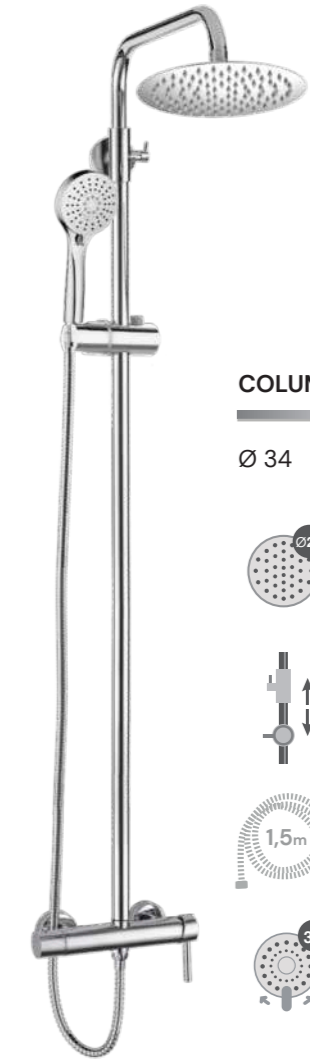

COLUMNA DUCHA MONOMANDO

Ø 34

AISI 304

- S ROCIADOR
- L Sprayer
- I Pulvérisateur
- M Pulverizador

- REGULABLE EN ALTURA
- Height adjustable
- Réglable en hauteur
- Ajustável em altura

- FLEXO 1,5 m
- Shower hose
- Flexible douche
- Mangueira chuveiro

- MANGO OMEGA
- Shower handle
- Douchette
- Chuveiro



REF. 68610

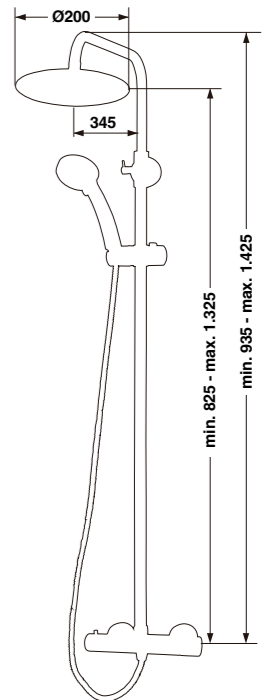

LÍNEA
essence
by **Wirtak**



NEVA



NEVA
BLACK



NAVY



STILO



OASIS



MEDICAL





Serie

NEVA

ACABADO
FINISH



Cromo
Chrome

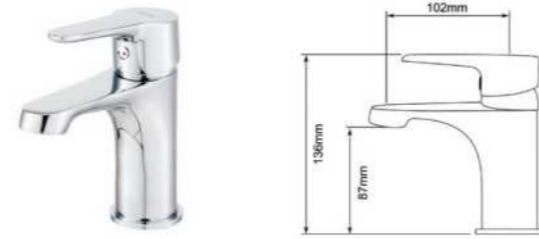

REF. 68171

Ø 35

MONOMANDO LAVABO

Single lever wash-basin mixer
Mitigeur lavabo
Monocomando lavatório

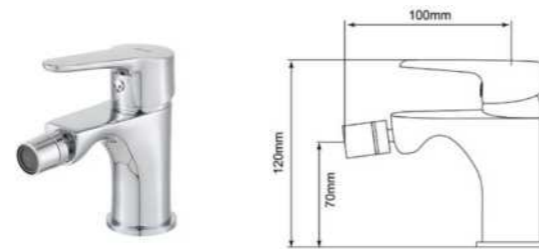

REF. 68172

MONOMANDO BIDÉ

Single lever bidet mixer
Mitigeur bidet
Monocomando bidé



REF. 68173

Ø 35

MONOMANDO BAÑO CON KIT

Single lever bath mixer
Mitigeur baignoire
Monocomando banho

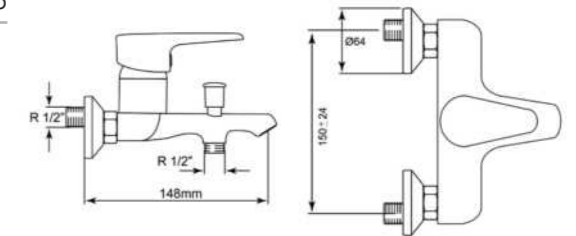

REF. 68174

Ø 35

MONOMANDO DUCHA CON KIT

Single lever shower mixer
Mitigeur douche
Monocomando duche

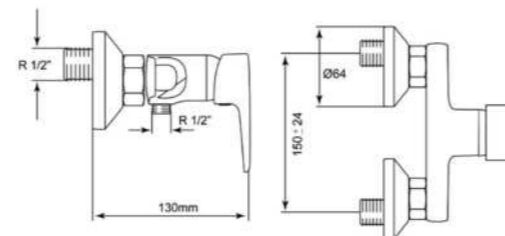

REF. 68175

Ø 35

MONOMANDO FREGADERA

Single lever sink mixer
Mitigeur évier
Monocomando cozinha

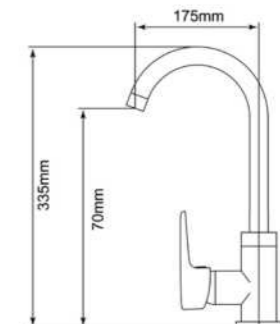

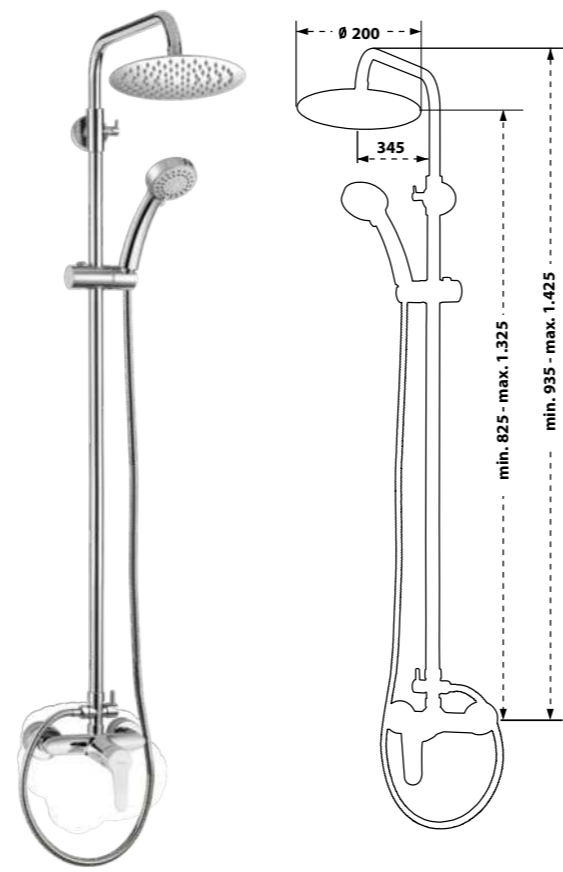

COLUMNA DUCHA MONOMANDO

Ø 34

AISI 304

- S** ROCIADOR
- L** Sprayer
- I** Pulvérisateur
- M** Pulverizador

- REGULABLE EN ALTURA**
- Height adjustable
- Réglable en hauteur
- Ajustável em altura

- FLEXO 1,5 m**
- Shower hose
- Flexible douche
- Manguera chuveiro

- MANGO EYRE**
- Shower handle
- Douchette
- Chuveiro



REF. 68170

essence
by Mirtak



Serie
NEVA BLACK

ACABADO
FINISH



Negro mate
Matt black

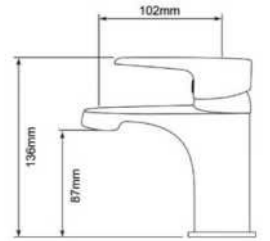

REF. 68501

Ø 35

MONOMANDO LAVABO

Single lever wash-basin mixer
Mitigeur lavabo
Monocomando lavatório

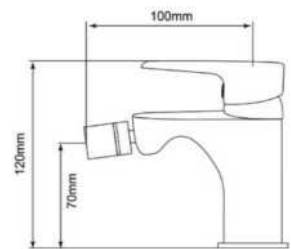

REF. 68502

Ø 35

MONOMANDO BIDÉ

Single lever bidet mixer
Mitigeur bidet
Monocomando bidé



REF. 68504

Ø 35



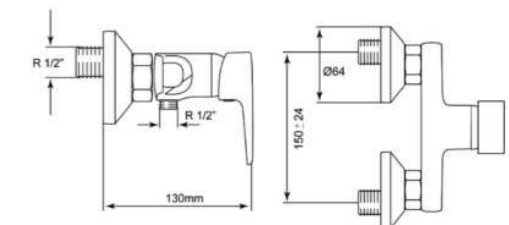

- MONOMANDO DUCHA CON KIT**
- Single lever shower mixer
- Mitigeur douche
- Monocomando duche





REF. 68503

Ø 35

-  **MONOMANDO BAÑO CON KIT**
-  Single lever bath mixer
-  Mitigeur baignoire
-  Monocomando banho

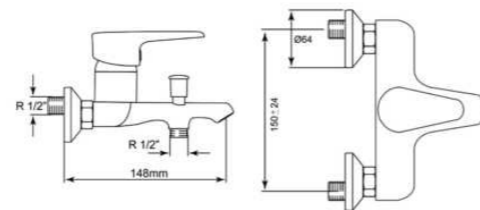

REF. 68505

Ø 35

- MONOMANDO FREGADERA**
- Single lever sink mixer
- Mitigeur évier
- Monocomando cozinha

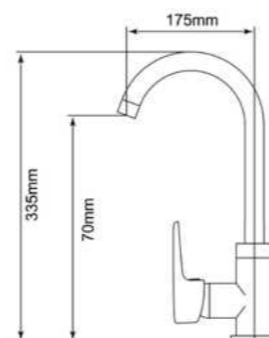





COLUMNA DUCHA MONOMANDO





Ø 35

AISI
304

-  **S ROCIADOR**
-  L Sprayer
-  I Pulvérisateur
-  M Pulverizador

-  **REGULABLE EN ALTURA**
-  Height adjustable
-  Réglable en hauteur
-  Ajustável em altura

-  **FLEJO 1,5 m**
-  Shower hose
-  Flexible douche
-  Mangueira chuveiro

-  **MANGO BANI**
-  Shower handle
-  Douchette
-  Chuveiro



REF. 68500

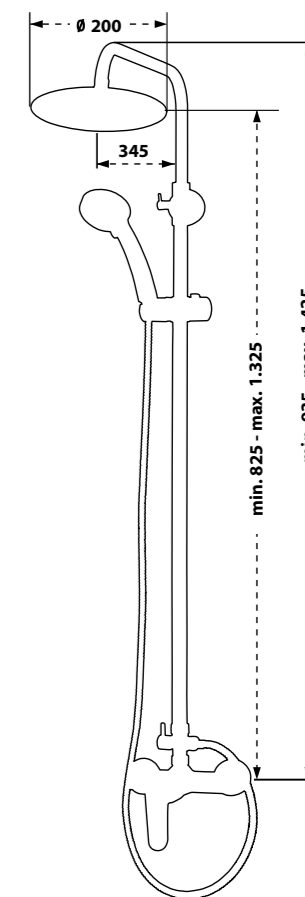



Serie
NAVY

ACABADO
FINISH



Cromo
Chrome



REF. 68081

MONOMANDO LAVABO

Single lever wash-basin mixer
Mitigeur lavabo
Monocomando lavatório

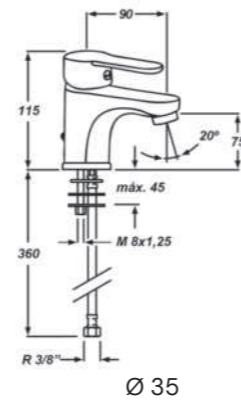

REF. 68082

MONOMANDO BIDÉ
Single lever bidet mixer
Mitigeur bidet
Monocomando bidé

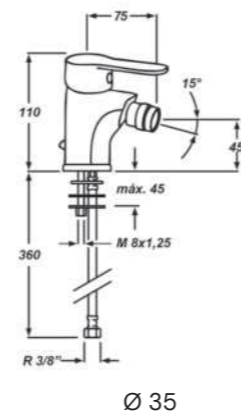

REF. 68083

Ø 35

MONOMANDO BAÑO CON KIT
Single lever bath mixer
Mitigeur baignoire
Monocomando banho

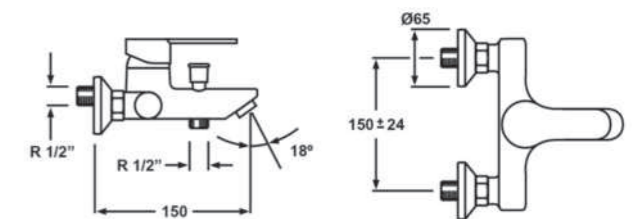

REF. 68085

Ø 35

MONOMANDO FREGADERA

Single lever sink mixer
Mitigeur évier
Monocomando cozinha

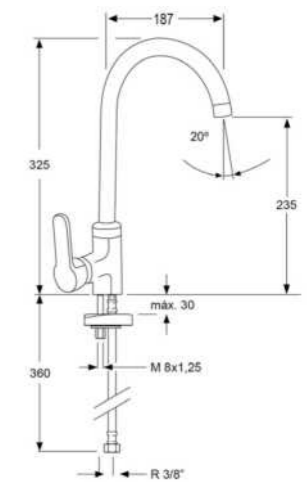

COLUMNA DUCHA MONOMANDO

Ø 35

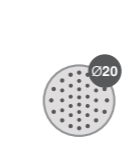

S ROCIADOR
L Sprayer
I Pulvérisateur
M Pulverizador

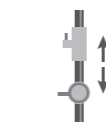

REGULABLE EN ALTURA
Height adjustable
Réglable en hauteur
Ajustável em altura



FLEXO 1,5 m
Shower hose
Flexible douche
Mangueira chuveiro



MANGO VERO
Shower handle
Douchette
Chuveiro

AISI
304

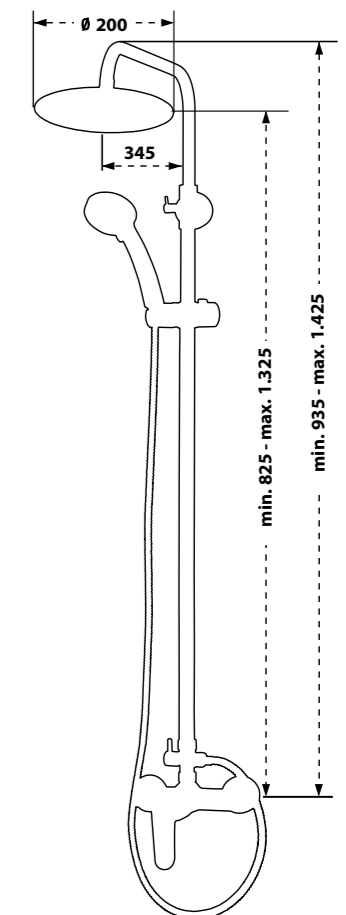

REF. 68084

Ø 35

MONOMANDO DUCHA CON KIT
Single lever shower mixer
Mitigeur douche
Monocomando duche

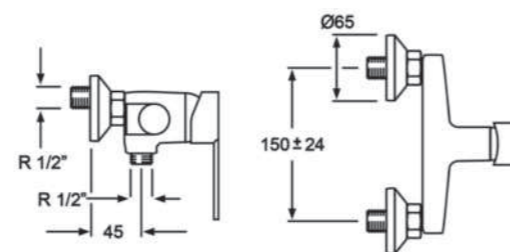

ACABADO
FINISH



Cromo
Chrome

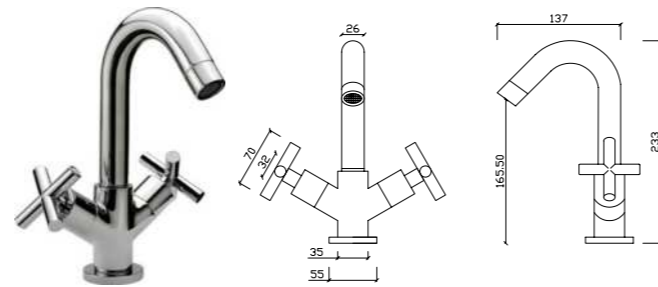

REF. 68021 Ø 1/2

BIMANDO LAVABO

Two handle wash-basin faucet
Robinet lavabo
Torneira Lavatório

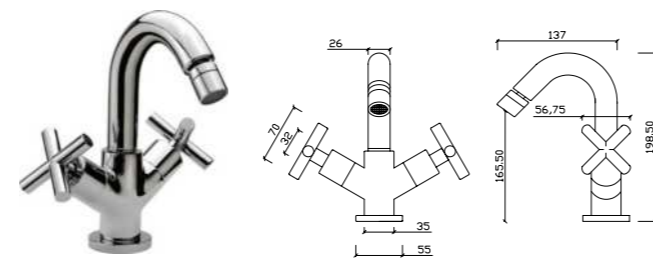

REF. 68022 Ø 1/2

BIMANDO BIDÉ

Two handle wash-basin faucet
Robinet bidet
Torneira bidé

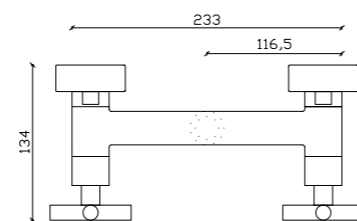

REF. 68024 Ø 1/2

BIMANDO DUCHA CON KIT

Two handle shower faucet
Robinet douche
Torneira duche



REF. 68023 Ø 1/2

BIMANDO BAÑO CON KIT

Two handle bath faucet
Robinet baignoire
Torneira banho

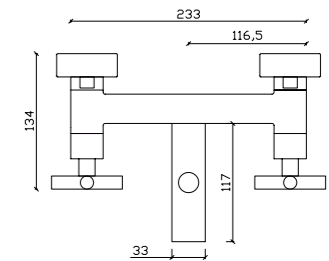

REF. 68026 Ø 1/2

BIMANDO FREGADERA

Two handle sink faucet
Robinet évier
Torneira cozinha

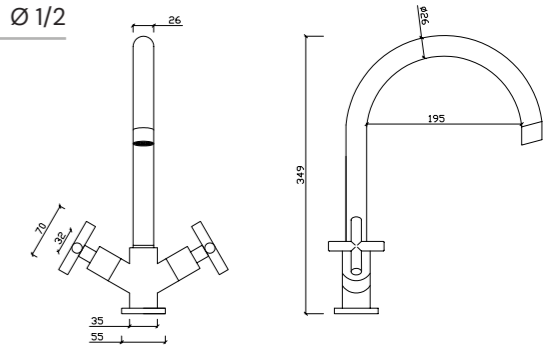

COLUMNA DUCHA MONOMANDO Ø 1/2

- S ROCIADOR
- L Sprayer
- I Pulvérisateur
- M Pulverizador

- REGULABLE EN ALTURA
- Height adjustable
- Réglable en hauteur
- Ajustável em altura

- FLEJO 1,5 m
- Shower hose
- Flexible douche
- Mangueira chuveiro

- MANGO TUBI
- Shower handle
- Douchette
- Chuveiro

AISI
304



REF. 68025

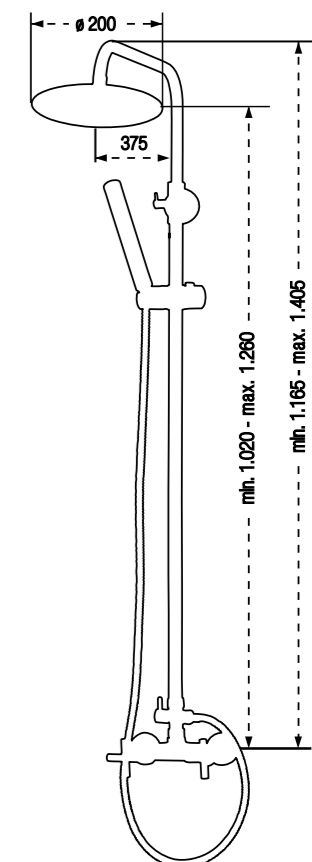



Serie
OASIS

ACABADO
FINISH



Cromo
Chrome

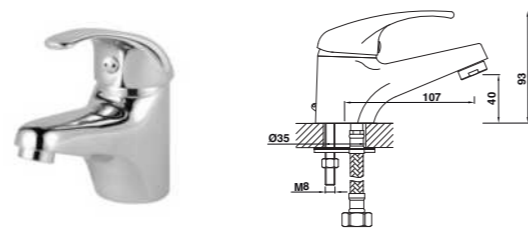

REF. 68011

Ø 40

MONOMANDO LAVABO

Single lever wash-basin mixer
Mitigeur lavabo
Monocomando lavatório

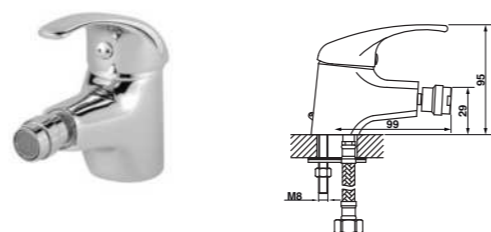

REF. 68012

Ø40

MONOMANDO BIDÉ

Single lever bidet mixer
Mitigeur bidet
Monocomando bidé



REF. 68013

Ø 40

MONOMANDO BAÑO CON KIT

Single lever bath mixer
Mitigeur baignoire
Monocomando banho

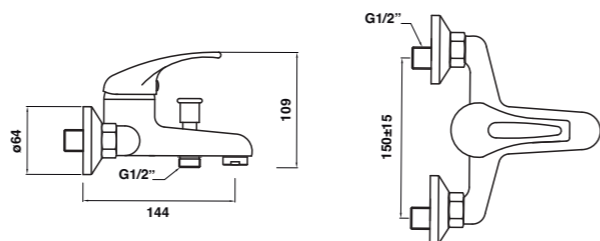

REF. 68014

Ø 40

MONOMANDO DUCHA CON KIT

Single lever shower mixer
Mitigeur douche
Monocomando duche

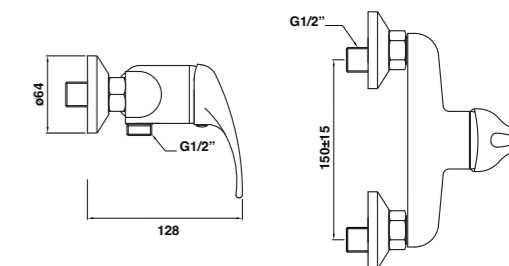

REF. 68016

Ø 40

MONOMANDO FREGADERA VERTICAL

Vertical single lever sink mixer
Mitigeur évier vertical
Monocomando cozinha vertical

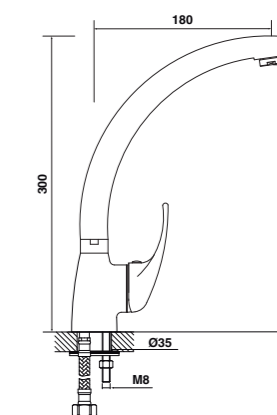

ACABADO
FINISH



Cromo
Chrome



Serie

MEDICAL

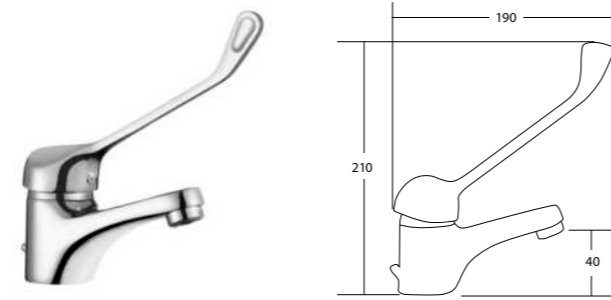

REF. 14052 Ø 40

MONOMANDO LAVABO
Single lever wash-basin mixer
Mitigeur lavabo
Monocomando lavatório

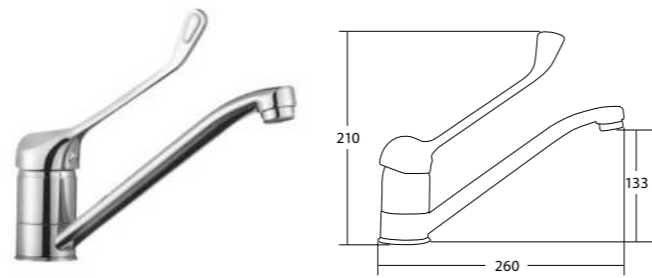

REF. 14053 Ø40

MONOMANDO FREGADERA HORIZONTAL
Single lever bidet mixer
Mitigeur bidet
Monocomando bidé

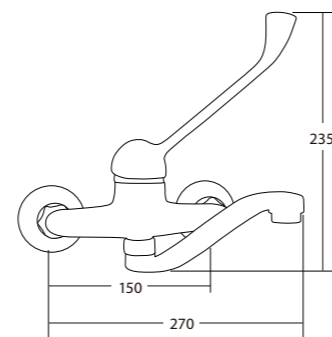

REF. 14054 Ø 40

MONOMANDO FREGADERA PARED (CAÑO BAJO)
Single lever bath mixer
Mitigeur baignoire
Monocomando banho



REF. 14055 Ø 40

MONOMANDO DUCHA CON KIT
Single lever shower mixer
Mitigeur douche
Monocomando duche

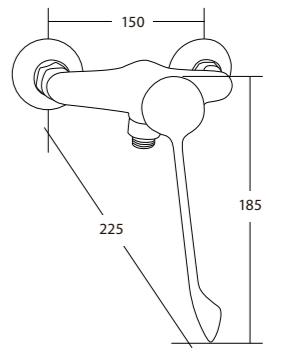

REF. 14051 Ø 1/2

GRIFO FRONTAL LARGO 1/2
Vertical single lever sink mixer
Mitigeur évier vertical
Monocomando cozinha vertical

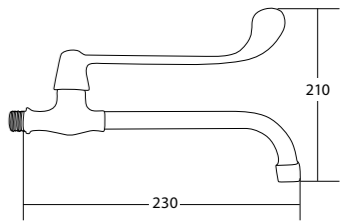



GRIFERÍA
TERMOSTÁTICA

THERMOSTATIC MIXERS

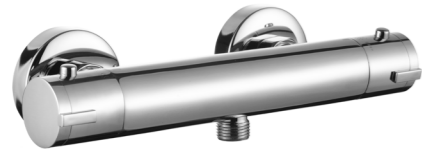

REF. 68040

Ø 30

TERMOSTÁTICA DUCHA STANDARD

Thermostatic shower mixer
Robinet de douche thermostatique
Torneira termostática para chuveiro

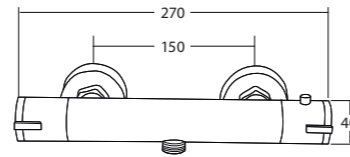

REF. 68044

Ø 30

TERMOSTÁTICA DUCHA SQUARE

Thermostatic shower mixer
Robinet de douche thermostatique
Torneira termostática para chuveiro

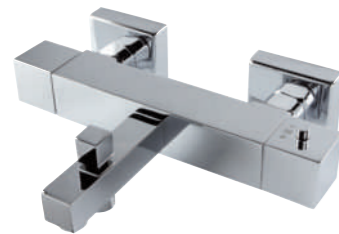
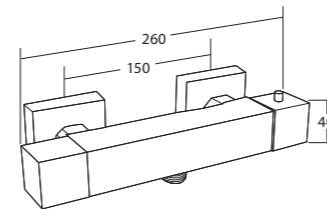

REF. 68045

Ø 30

TERMOSTÁTICA BAÑO SQUARE

Thermostatic bath mixer
Robinet thermostatique pour baignoire
Torneira termostática para banho

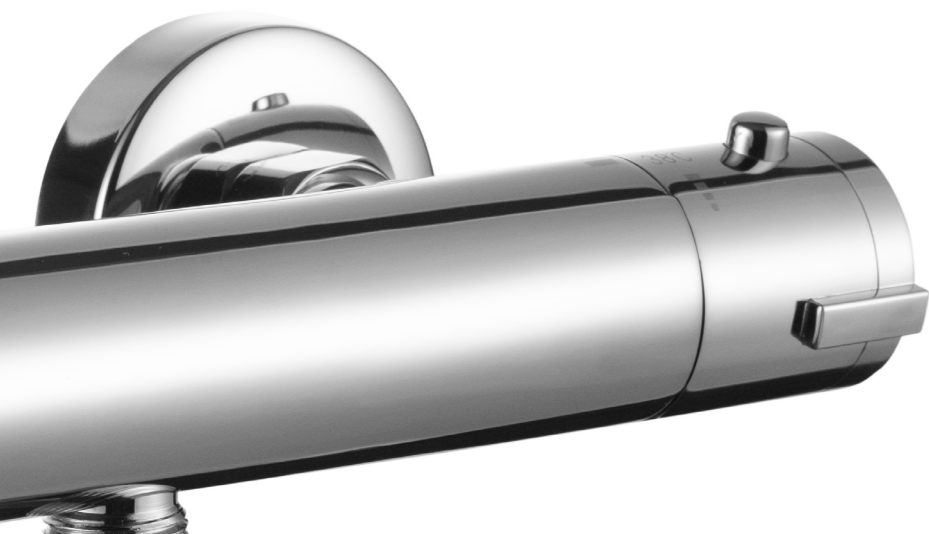
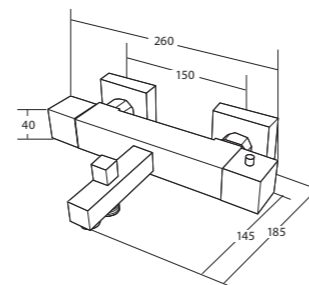

REF. 68041

Ø 34

TERMOSTÁTICA BAÑO STANDARD

Thermostatic bath mixer
Robinet thermostatique pour baignoire
Torneira termostática para banho

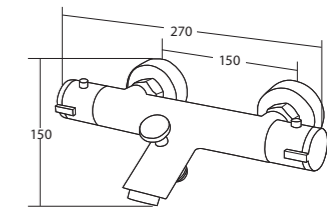

COLUMNA DUCHA TERMOSTÁTICA SQ-77

REF. 68077

Ø 35

AISI 304

-  **S ROCIADOR**
- L Sprayer**
- I Pulvérisateur**
- M Pulverizador**

-  **REGULABLE EN ALTURA**
- Height adjustable**
- Réglable en hauteur**
- Ajustável em altura**

-  **FLEXO 1,5 m**
- Shower hose**
- Flexible douche**
- Mangueira chuveiro**

-  **MANGO NERVIÓN**
- Shower handle**
- Douchette**
- Chuveiro**

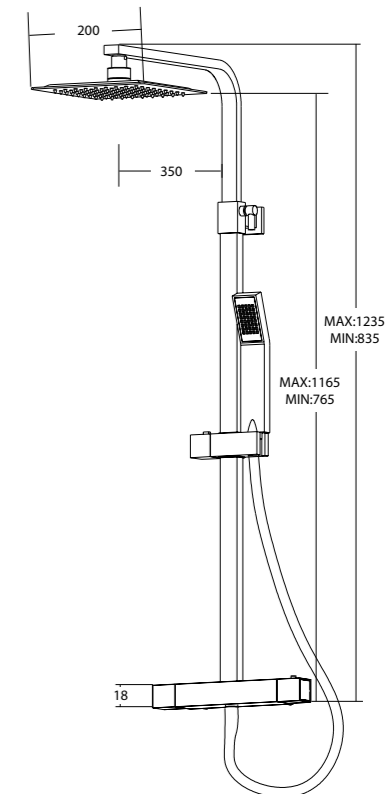

COLUMNA DUCHA TERMOSTÁTICA VULKAN

REF. 68064

Ø 34

AISI 304



S ROCIADOR
L Sprayer
I Pulvérisateur
M Pulverizador

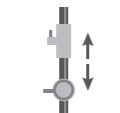

REGULABLE EN ALTURA
 Height adjustable
 Réglable en hauteur
 Ajustável em altura



FLEXO 1,5 m
 Shower hose
 Flexible douche
 Mangueira chuveiro

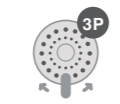

MANGO BANI BLACK
 Shower handle
 Douchette
 Chuveiro

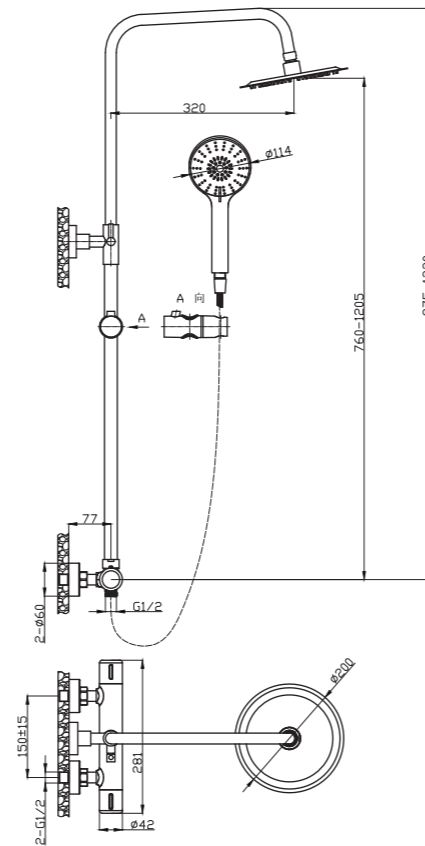

COLUMNA DUCHA TERMOSTÁTICA MAXI-2

REF. 68057

Ø 34

AISI 304



S ROCIADOR
L Sprayer
I Pulvérisateur
M Pulverizador

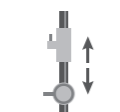

REGULABLE EN ALTURA
 Height adjustable
 Réglable en hauteur
 Ajustável em altura



FLEXO 1,5 m
 Shower hose
 Flexible douche
 Mangueira chuveiro



MANGO VERO
 Shower handle
 Douchette
 Chuveiro

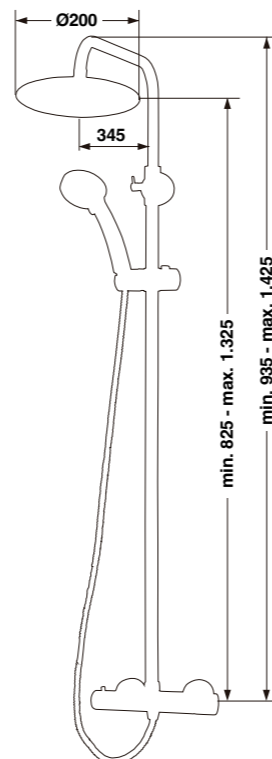

GRIFERÍA COCINA

KITCHEN MIXERS



Fregaderas
MK LINE



REF. 68096

Ø 35

TENNA MONOMANDO FREGADERA BLACK
 Black single lever sink mixer
 Mitigeur évier noir
 Monocomando cozinha preto

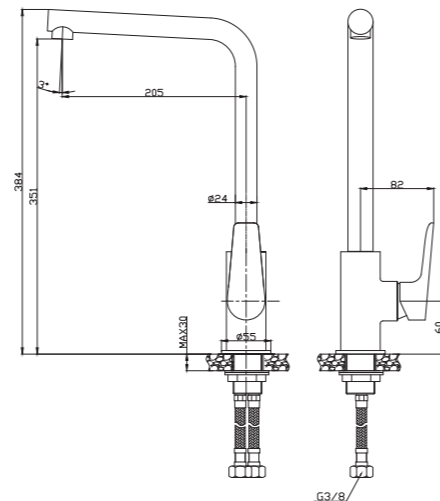

REF. 68095

Ø 35

TENNA MONOMANDO FREGADERA
 Single lever sink mixer
 Mitigeur évier
 Monocomando cozinha

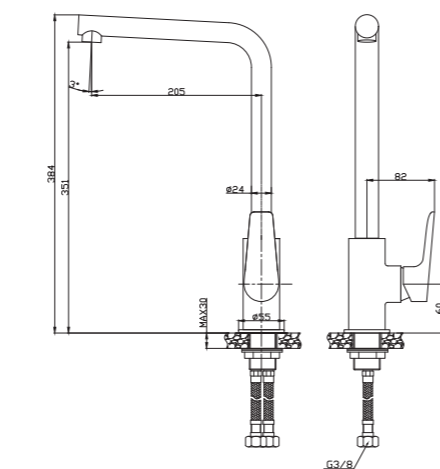

REF. 68135

Ø 30

VEGA MONOMANDO FREGADERA
 Single lever sink mixer
 Mitigeur évier
 Monocomando cozinha

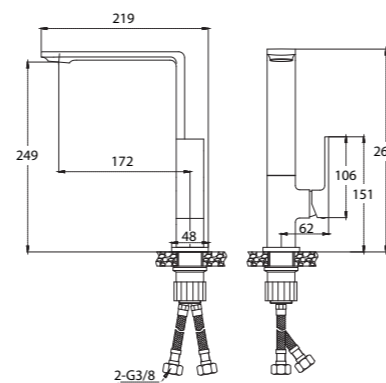

REF. 68125

Ø 30

VEGA MONOMANDO FREGADERA NEGRO
 Black single lever sink mixer
 Mitigeur évier noir
 Monocomando cozinha preto

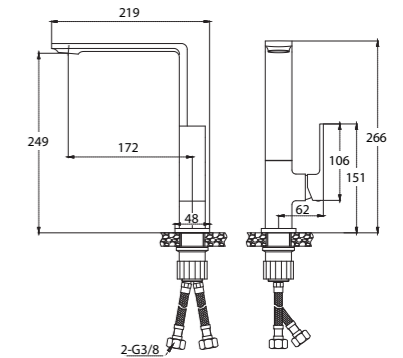



REF. 68425

Ø 25

MAIA ORO DARK MONOMANDO FREGADERA
Single lever sink mixer
Mitigeur évier
Monocomando cozinha

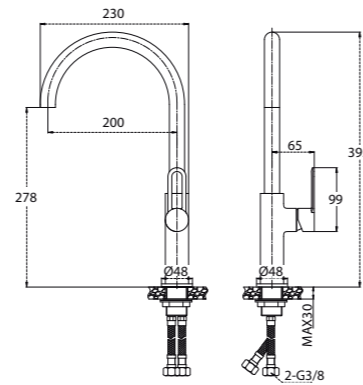

REF. 68185

Ø 25

SVELTA
MONOMANDO FREGADERA
Single lever sink mixer
Mitigeur évier
Monocomando cozinha

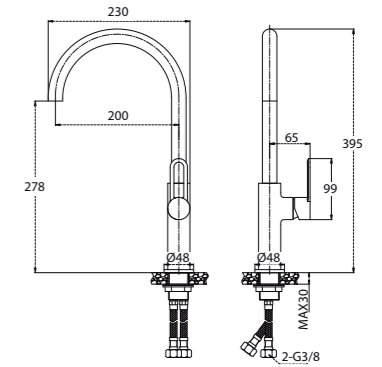

REF. 68145

Ø 25

MAIA MONOMANDO FREGADERA
Single lever sink mixer
Mitigeur évier
Monocomando cozinha

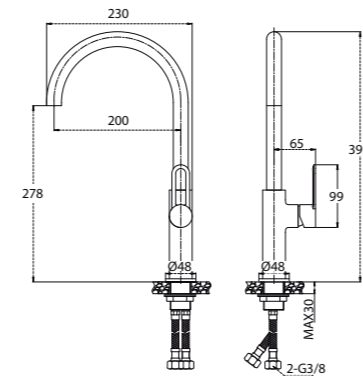

REF. 68405

Ø 25

SVELTA FULL BLACK
MONOMANDO FREGADERA
Black single lever sink mixer
Mitigeur évier noir
Monocomando cozinha preto

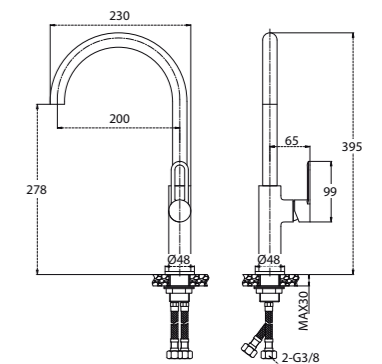

REF. 68155

Ø 25

MAIA BLACK MONOMANDO FREGADERA
Black single lever sink mixer
Mitigeur évier noir
Monocomando cozinha preto

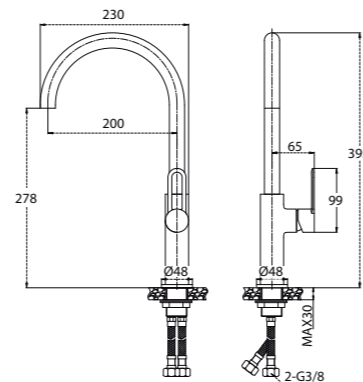

REF. 68195

Ø 25

SVELTA BLACK MONOMANDO FREGADERA
Black single lever sink mixer
Mitigeur évier noir
Monocomando cozinha preto

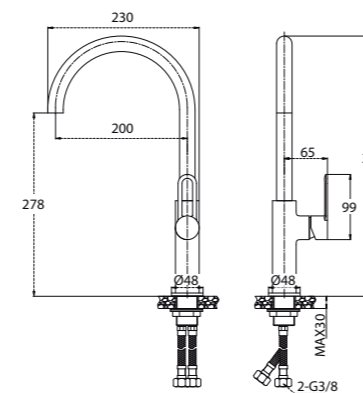

EFECTO GRANTO / GRANITE EFFECT

OSMOSIS



REF. 65814

Ø 35

F14 MONOMANDO FREGADERA OSMOSIS

Osmosis single lever sink mixer
Mitigeur évier Osmosis
Monocomando cozinha Osmosis

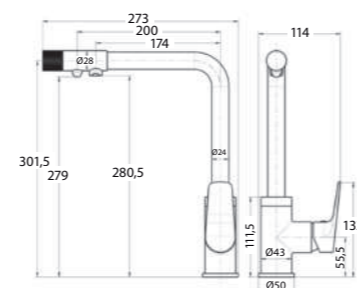

REF. 65813

Ø 35

F13 MONOMANDO FREGADERA OSMOSIS CENTURY

Osmosis single lever sink mixer (2 handles)
Mitigeur évier Osmosis (2 poignées)
Monocomando cozinha Osmosis (2 alças)

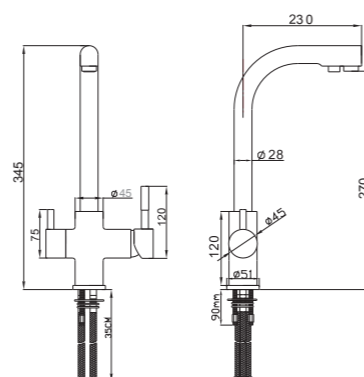

EXTRAÍBLES



REF. 65820

Ø 35

F20 MONOMANDO FREGADERA EXTRAÍBLE

Removable single lever sink mixer
Mitigeur évier extractable
Monocomando cozinha flexível

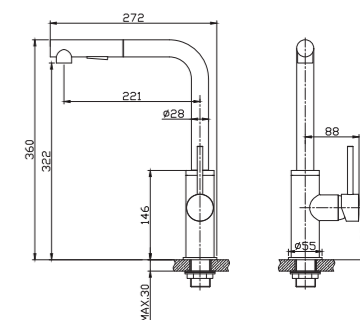

REF. 65823

Ø 35

F23 MONOMANDO FREGADERA EXTRAÍBLE

Removable single lever sink mixer
Mitigeur évier extractable
Monocomando cozinha flexível

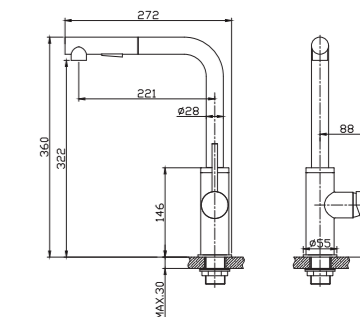

REF. 65805

Ø 40

OASIS MONOMANDO FREGADERA EXTRAÍBLE HORIZONTAL

Horizontal removable single lever sink
Mitigeur évier horizontal extractable
Monocomando cozinha horizontal removível

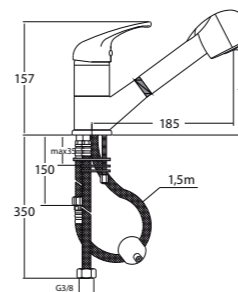

REF. 65806

Ø 40

OASIS MONOMANDO FREGADERA EXTRAÍBLE VERTICAL

Vertical removable single lever sink mixer
Mitigeur évier vertical extractable
Monocomando cozinha vertical removível

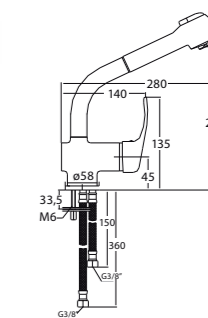

FLEXIBLES



REF. 65809

Ø 25

F9 MONOMANDO FREGADERA CON MUELLE EXTRAÍBLE

Removable flexible single lever sink mixer
Mitigeur évier extractable flexible
Monocomando cozinha flexível removível

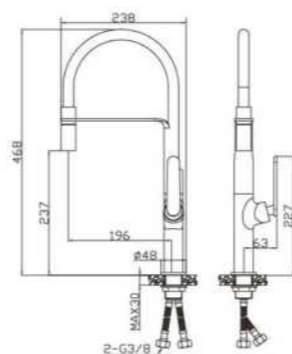

REF. 65808

Ø 25

F8 MONOMANDO FREGADERA EXTRAÍBLE FLEXIBLE

Removable flexible single lever sink mixer
Mitigeur évier extractable flexible
Monocomando cozinha flexível removível

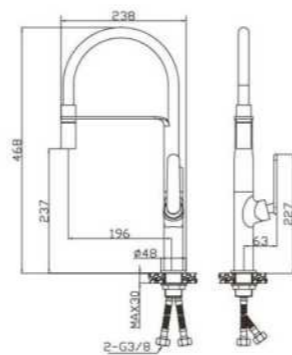

MONOMANDOFREGADERA FLEXIBLE

Ø 35

Flexible single lever sink mixer
Mitigeur évier flexible
Monocomando cozinha flexível

●
F18
REF. 65818

●
F21
REF. 65821

○
F19
REF. 65819

●
F22
REF. 65822

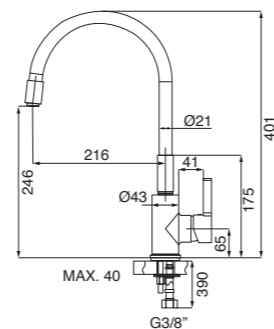

Fregaderas

ESSENCE



REF. 68175 Ø 35

NEVA MONOMANDO FREGADERA

Single lever sink mixer
Mitigeur évier
Monocomando cozinha

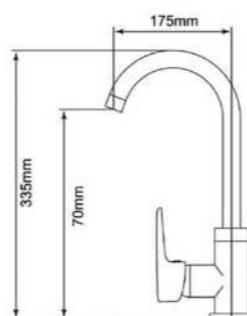

REF. 68085 Ø 35

NAVY MONOMANDO FREGADERA

Single lever sink mixer
Mitigeur évier
Monocomando cozinha

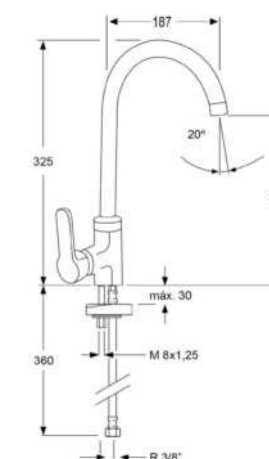

REF. 68026 Ø 1/2

STILO BIMANDO FREGADERA

Two handle sink faucet
Robinet évier
Torneira cozinha

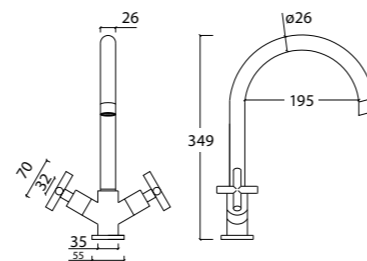

REF. 68016 Ø 40

OASIS MONOMANDO FREGADERA VERTICAL

Vertical single lever sink mixer
Mitigeur évier vertical
Monocomando cozinha vertical

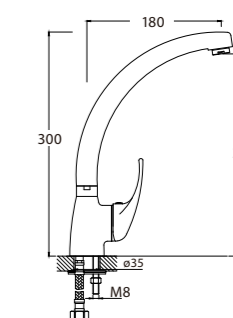

REF. 65802 Ø 40

OASIS MONOMANDO FREGADERA VERTICAL (CAÑO FUNDIDO)

Vertical single lever sink mixer (cast spout)
Mitigeur évier vertical (bec fondu)
Monocomando cozinha vertical (bico fundido)

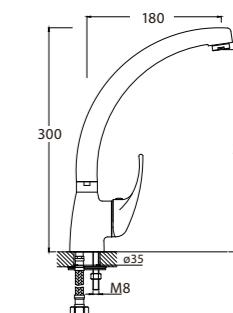

REF. 65801 Ø 40

OASIS MONOMANDO FREGADERA VERTICAL BLANCO

White vertical single lever sink mixer
Mitigeur évier blanc
Monocomando cozinha vertical branco

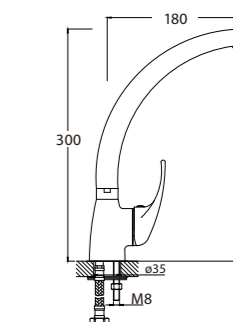

REF. 65812 Ø 35

CENTURY ABATIBLE MONOMANDO FREGADERA

Folding single lever sink mixer
Mitigeur évier pliant
Monocomando cozinha dobrando

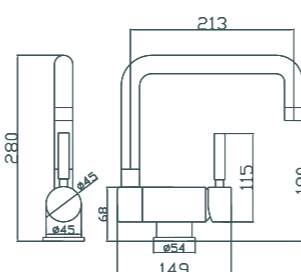



REF. 65807

Ø 40

OASIS MONOMANDO FREGADERA VERTICAL TIERRA FRANCIA

Terre France vertical single lever sink mixer
Mitigeur évier vertical Terre France
Monocomando cozinha vertical Terre France

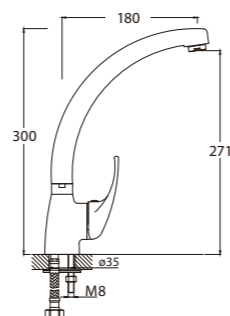

MONOMANDO FREGADERA PARED

Ø 40

Wall single lever sink mixer
Mitigeur évier mural corp
Monocomando cozinha parede corpo

REF. 65815

15 cm cuerpo / body / corp / corpo

REF. 65816

11 cm cuerpo / body / corp / corpo

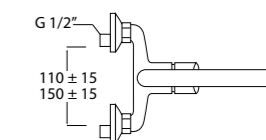
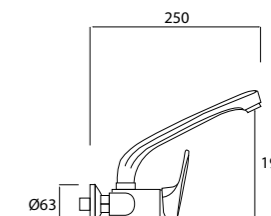

REF. 65817

Ø 40

OASIS MONOMANDO FREGADERA "ECO" VERTICAL

Vertical "ECO" single lever sink mixer
Mitigeur évier "ECO" vertical
Monocomando cozinha "ECO" vertical

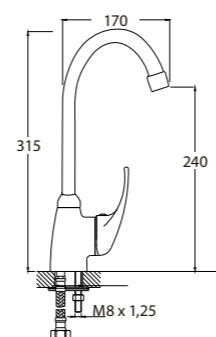

REF. 68018

Ø 40

MONOMANDO FREGADERA PARED (CAÑO FUNDIDO)

Wall single lever sink mixer (cast spout)
Mitigeur évier mural (bec fondu)
Monocomando cozinha parede (bico fundido)

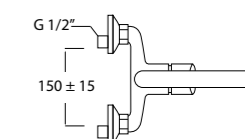
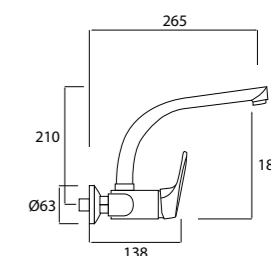

REF. 14054

Ø 40

MEDICAL MONOMANDO FREGADERA PARED (CAÑO BAJO)

Wall single lever sink mixer (low spout)
Mitigeur évier mural (bec bas)
Monocomando cozinha parede (bico baixo)

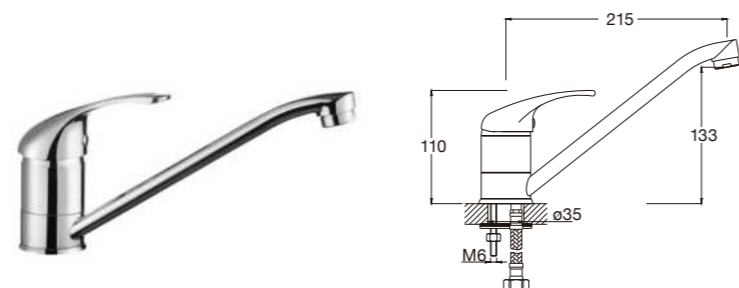
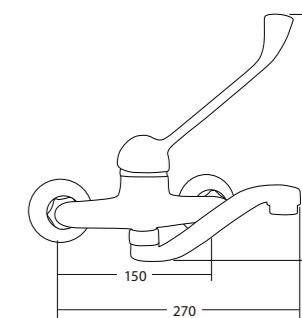

REF. 68017

Ø 40

OASIS MONOMANDO FREGADERA HORIZONTAL

Horizontal single lever sink mixer
Mitigeur évier horizontal
Monocomando cozinha horizontal



REF. 14053

Ø 40

MEDICAL MONOMANDO FREGADERA HORIZONTAL

Horizontal single lever sink mixer
Mitigeur évier horizontal
Monocomando cozinha horizontal

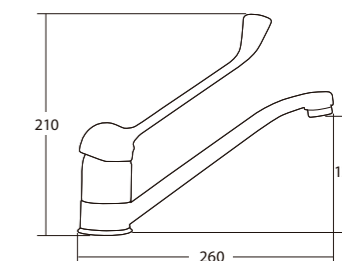

Fregaderas

BASIC



BATERIA FREGADERA CAÑO HORIZONTAL Ø 1/2

Wall sink mixer horizontal spout
Robinet évier bec horizontal
Torneira cozinha bico horizontal

REF. 65901
11 cm cuerpo / body / corp / corpo
22 cm caño / spout / bec / bico

REF. 65900
11 cm cuerpo / body / corp / corpo
18 cm caño / spout / bec / bico

REF. 65903
15 cm cuerpo / body / corp / corpo
22 cm caño / spout / bec / bico

REF. 65907
15 cm cuerpo / body / corp / corpo
18 cm caño / spout / bec / bico

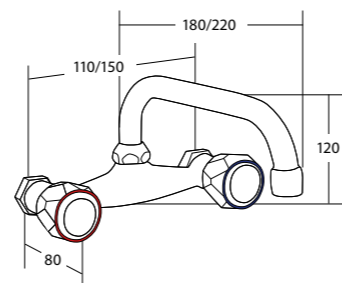

BATERIA FREGADERA CAÑO VERTICAL Ø 1/2

Wall sink mixer vertical spout
Robinet évier bec vertical
Torneira cozinha bico vertical

REF. 65905
11 cm cuerpo / body / corp / corpo

REF. 65904
15 cm cuerpo / body / corp / corpo

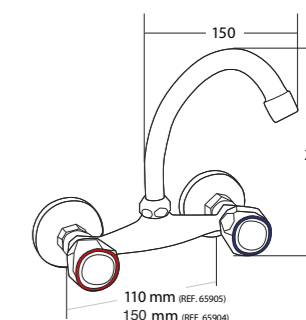

REF. 65910 Ø 1/2

GRIFO MONOBLOC FREGADERA CAÑO VERTICAL

Sink tap vertical spout (1 track)
Robinet évier bec vertical (1 voie)
Torneira cozinha bico vertical (1 via)

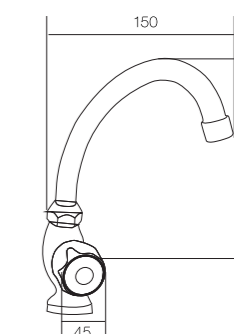

REF. 65902 Ø 1/2

GRIFO FREGADERA GIRATORIO CAÑO HORIZONTAL

Wall sink tap horizontal spout (1 track)
Robinet évier mural bec horizontal (1 voie)
Torneira cozinha parede bico horizontal (1 via)

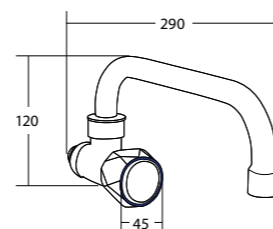

REF. 65906 Ø 1/2

GRIFO FREGADERA GIRATORIO CAÑO VERTICAL

Wall sink tap vertical spout (1 track)
Robinet évier mural bec vertical (1 voie)
Torneira cozinha parede bico vertical (1 via)

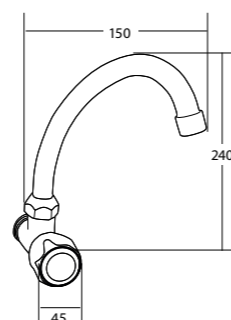

GRIFERÍA
ELECTRÓNICA

ELECTRONIC TAPS





STAR SQUARE GRIFO ELECTRONICO LAVABO

Electronic wash-basin tap
Robinet lavabo électronique
Torneira lavatório eletrônica

REF. 14028
1 agua / track / voie / via

REF. 14027
2 aguas / tracks / voies / vias

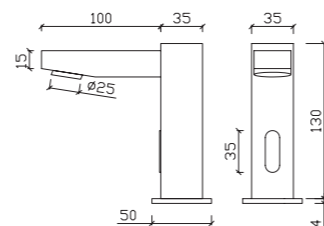

STAR SQUARE GRIFO EMPOTRADO ELECTRÓNICO

Built-in electronic wash-basin tap
Robinet encastré mural électronique
Torneira lavatório embutida eletrônica

REF. 14018
1 agua / track / voie / via

REF. 14017
2 aguas / tracks / voies / vias

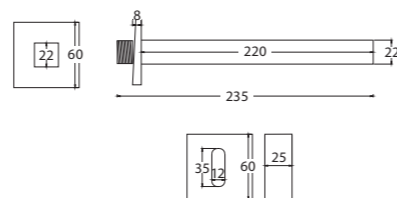

STAR ROUND GRIFO ELECTRÓNICO LAVABO

Electronic wash-basin tap
Robinet lavabo électronique
Torneira lavatório eletrônica

REF. 14034
1 agua / track / voie / via

REF. 14029
2 aguas / tracks / voies / vias

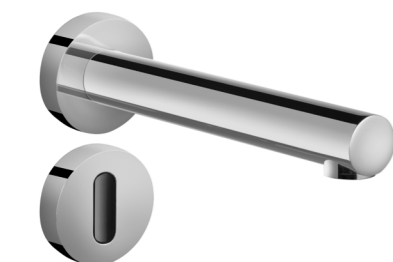
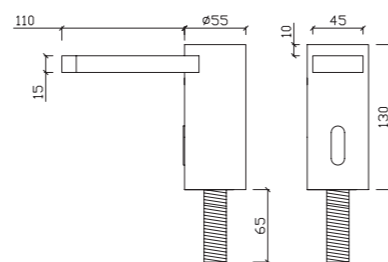

STAR ROUND GRIFO EMPOTRADO ELECTRÓNICO LAVABO

Built-in electronic wash-basin tap
Robinet encastré mural électronique
Torneira lavatório embutida eletrônica

REF. 14016
1 agua / track / voie / via

REF. 14015
2 aguas / tracks / voies / vias

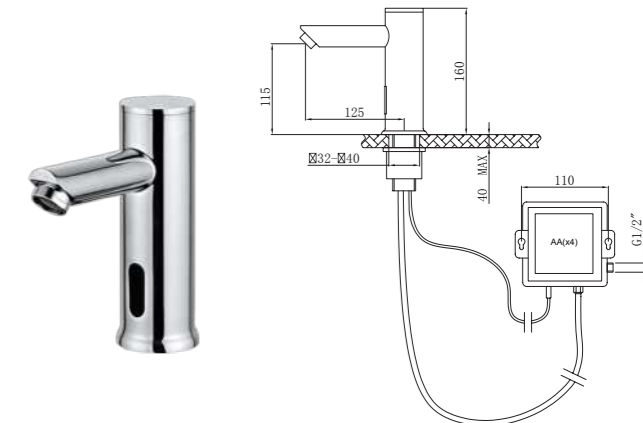
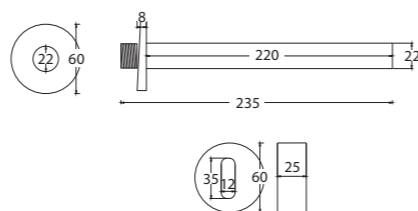

ERGO GRIFO ELECTRÓNICO LAVABO

Electronic wash-basin tap
Robinet lavabo électronique
Torneira lavatório eletrônica

REF. 14026
1 agua / track / voie / via

REF. 14025
2 aguas / tracks / voies / vias

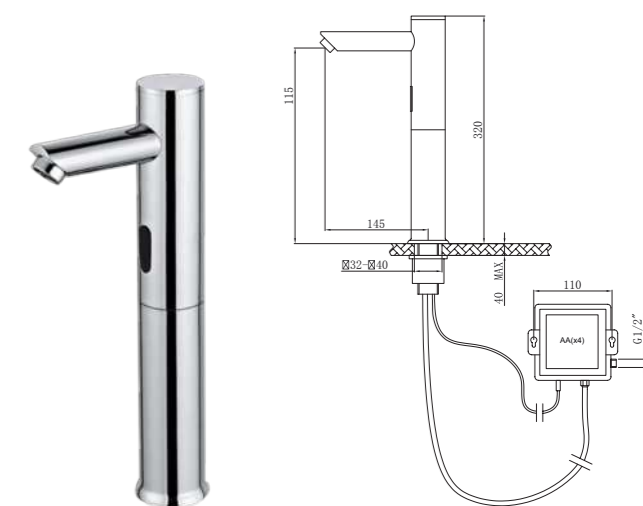

ERGO GRIFO ELECTRÓNICO LAVABO ALTO

High electronic wash-basin tap
Robinet lavabo électronique haut
Torneira lavatório eletrônica alto

REF. 14024
1 agua / track / voie / via

REF. 14023
2 aguas / tracks / voies / vias

GRIFERÍA
TEMPORIZADA

TIMER TAPS





REF. 14031

GRIFO T1 TEMPORIZADO LAVABO

Wash-basin timer tap
Robinet lavabo temporisé
Torneira temporizador lavatório

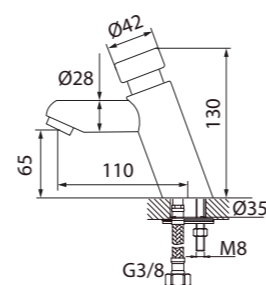

REF. 59103

ROCIADOR LATÓN TOMA EMPOTRAR 1/2

Brass shower head
Laiton pomme douche
Lavar a cabeça latão

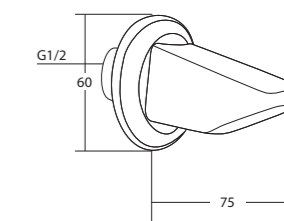

REF. 14032

GRIFO T2 MEZCLADOR TEMPORIZADO LAVABO

Wash-basin timer mixer
Mitigeur lavabo temporisé
Torneira misturador temporizador lavatório

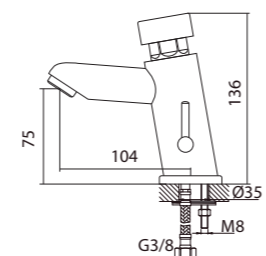

REF. 14047

FLUXOMETRO WC ENTRADA 3/4 SALIDA Ø28

WC timer tap 3/4 - Ø28
Robinet WC temporisé 3/4 - Ø28
Torneira WC temporizador 3/4 - Ø28

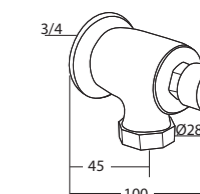

REF. 14030

GRIFO TEMPORIZADOR LAVABO

Wash-basin timer tap
Robinet lavabo temporisé
Torneira temporizador lavatório

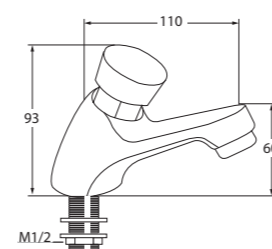

REF. 14035

GRIFO TEMPORIZADO URINARIO FRONTAL

Wall-mounted urinal timer tap
Robinet d'urinoir temporisé
Torneira temporizador para urinol

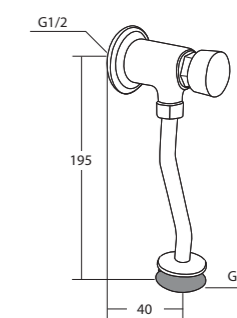

REF. 14033

GRIFO TEMPORIZADOR FRONTAL

Wash-basin frontal timer tap
Robinet d'évier temporisé
Torneira temporizador frontal

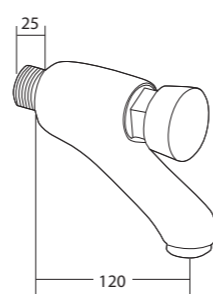

REF. 14036

ACCESORIO TEMPORIZADO URINARIO 15,5 cm

Urinal timer tap accessory
Accessoire robinet d'urinoir temporisé
Acessório torneira urinol temporizador

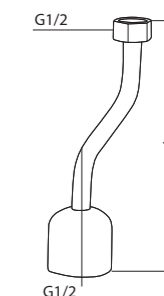

REF. 14037

GRIFO TEMPORIZADO DUCHA EMPOTRAR

Built-in timed shower tap
Robinet encastré douche temporisé
Torneira embutida duche temporizador

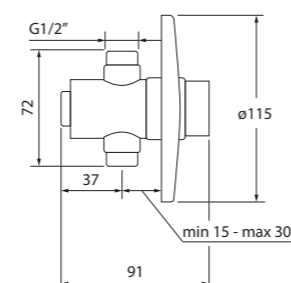

REF. 14038

GRIFO TEMPORIZADO EMPOTRAR URINARIO

Built-in urinal timer tap
Robinet encastré d'urinoir temporisé
Torneira embutida urinol temporizador

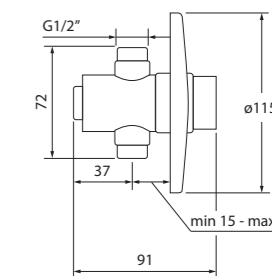

GRIFERÍA EMPOTRADA Y PEDALES

BUILT-IN MIXERS AND PEDALS

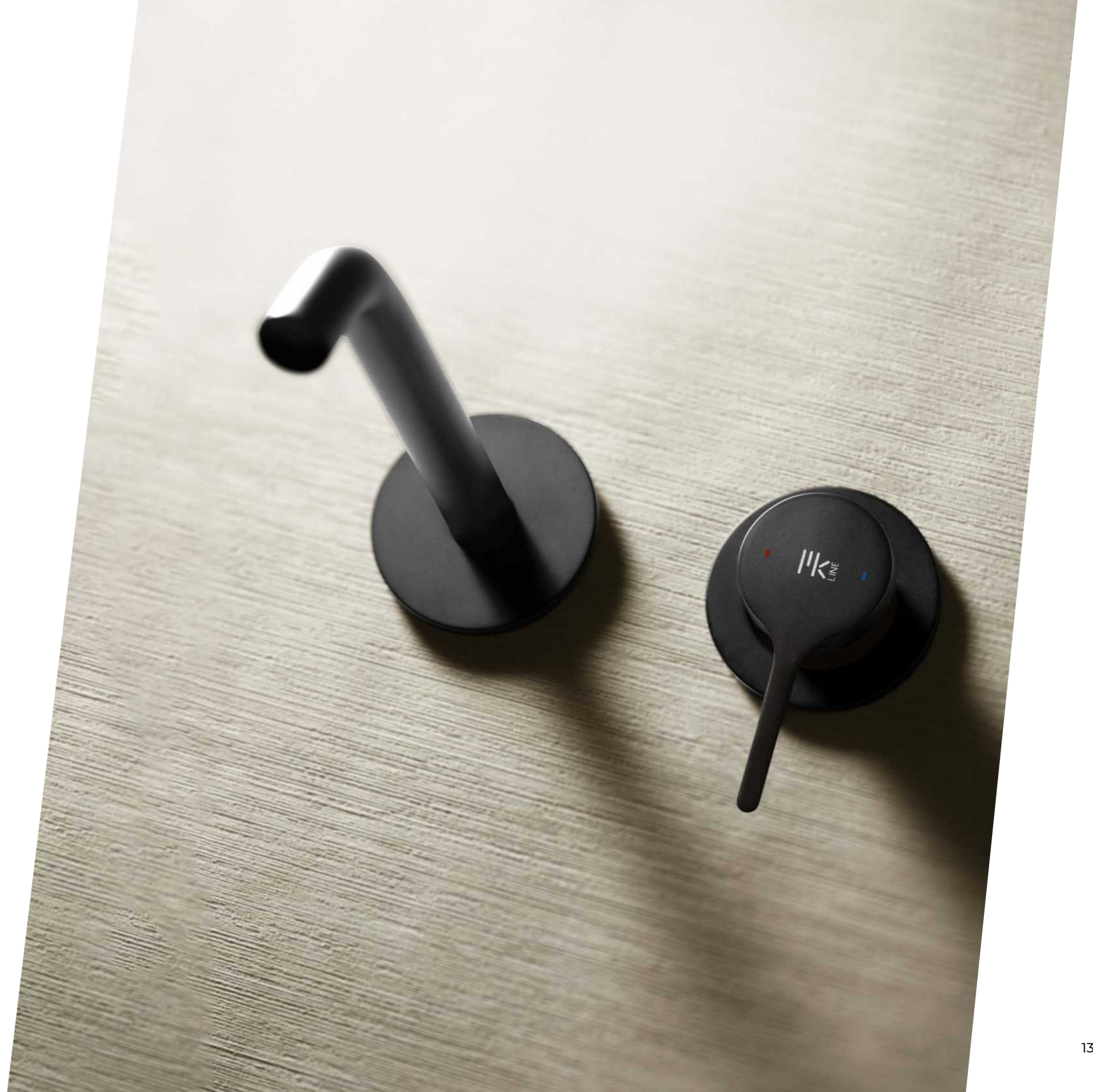



REF. 68447 Ø 35

ERA BLACK MONOMANDO EMPOTRADO LAVABO
 Built-in single lever washbasin mixer
 Mitigeur lavabo à encastrer
 Monocomando lavatorio embutida

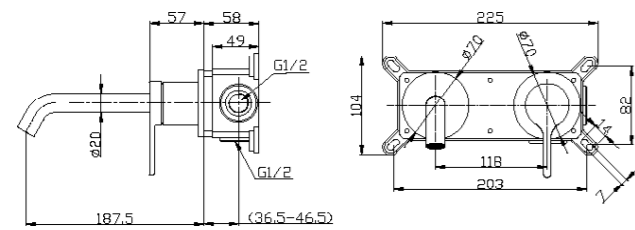
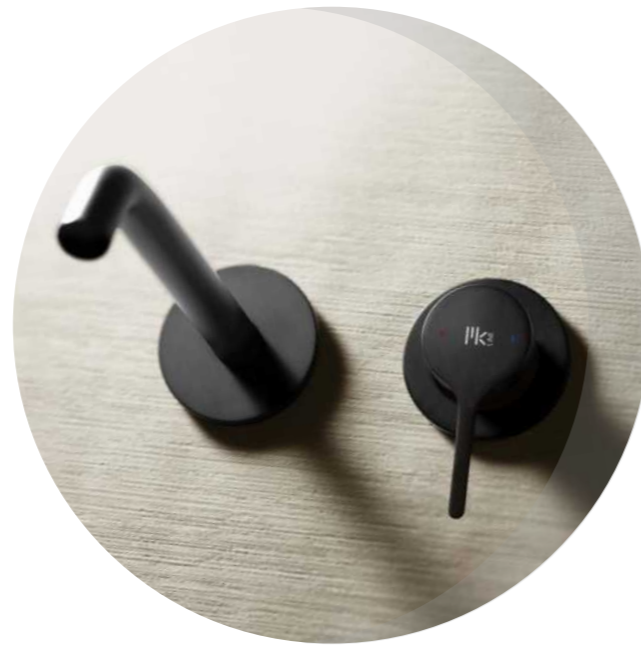

REF. 68437 Ø 35

ERA MONOMANDO EMPOTRADO LAVABO
 Built-in single lever washbasin mixer
 Mitigeur lavabo à encastrer
 Monocomando lavatorio embutida

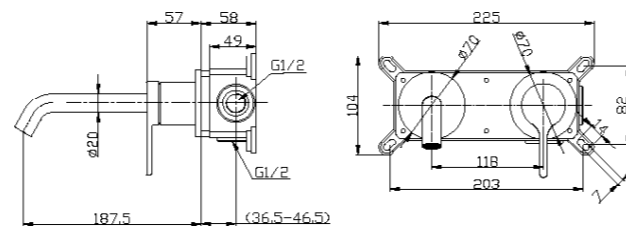

REF. 14046

CAÑO GIRATORIO VERTICAL INCLINADO
 Inclined rotatory pipe
 Bec pivotat vertical incliné
 Bico giratório vertical inclinado

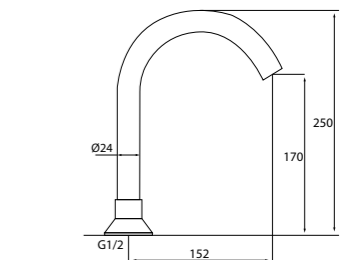

REF. 68234

BEST MONOMANDO EMPOTRAR 1 VÍA
 Built-in 1 track shower mixer
 Mitigeur douche encastré 1 voie
 Monocomando duche embutida 1 via

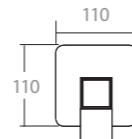

REF. 68257

MONOMANDO BIDÉ CROMO EMPOTRADO
 Chrome single lever recessed bidet
 Bidet encastré à leiver unique chromé
 Bidé encastrado monocomando cromado

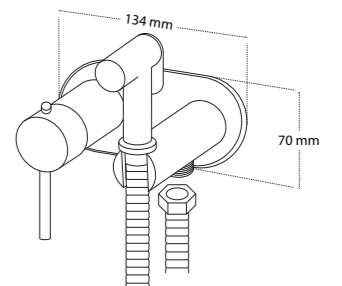

REF. 68254

CENTURY MONOMANDO DUCHA EMPOTRAR 1 VÍA
 Built-in 1 track shower mixer
 Mitigeur douche encastré 1 voie
 Monocomando duche embutida 1 via

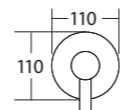

REF. 68267

MONOMANDO BIDÉ NEGRO MATE EMPOTRADO
 Matt black single lever recessed bidet
 Bidet encastré à leiver unique noir mat
 Bidé encastrado monocomando preto mate

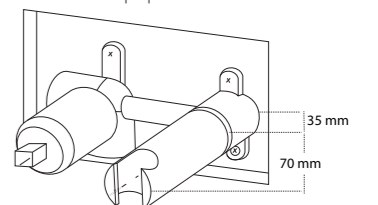

REF. 14041

GRIFO PEDAL 1 AGUA ECO
 Pedal tap 1 track
 Robinet pédale 1 voie
 Torneira pedal 1 via

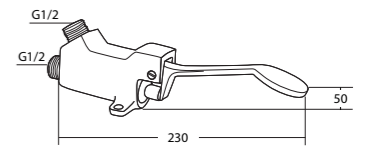

REF. 14048

GRIFO PEDAL 2 AGUAS ECO
 Pedal mixer tap
 Mitigeur pédale
 Torneira misturador pedal

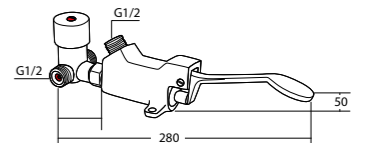

ACCESORIOS

ACCESSORIES





Serie
DECUA



REF. CA-30621

TOALLERO ANILLA CROMO

Towel ring
Porte-serviettes ring
Toalheiro de anel

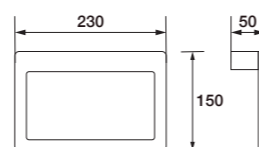

REF. CA-30625

PERCHA CROMO (2 UNIDADES)

Hanger
Cintre
Cabide

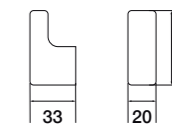

REF. CA-30622

PORTARROLLOS CROMO

Paper holder
Porte-rouleau
Porta-rolos

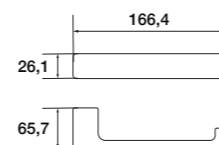

REF. CA-30626

TOALLERO BARRA CROMO 45 CM

Towel rail
Porte-serviettes droit
Toalheiro barra

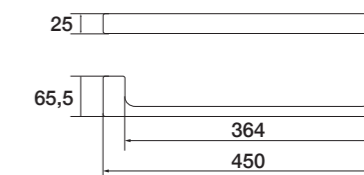

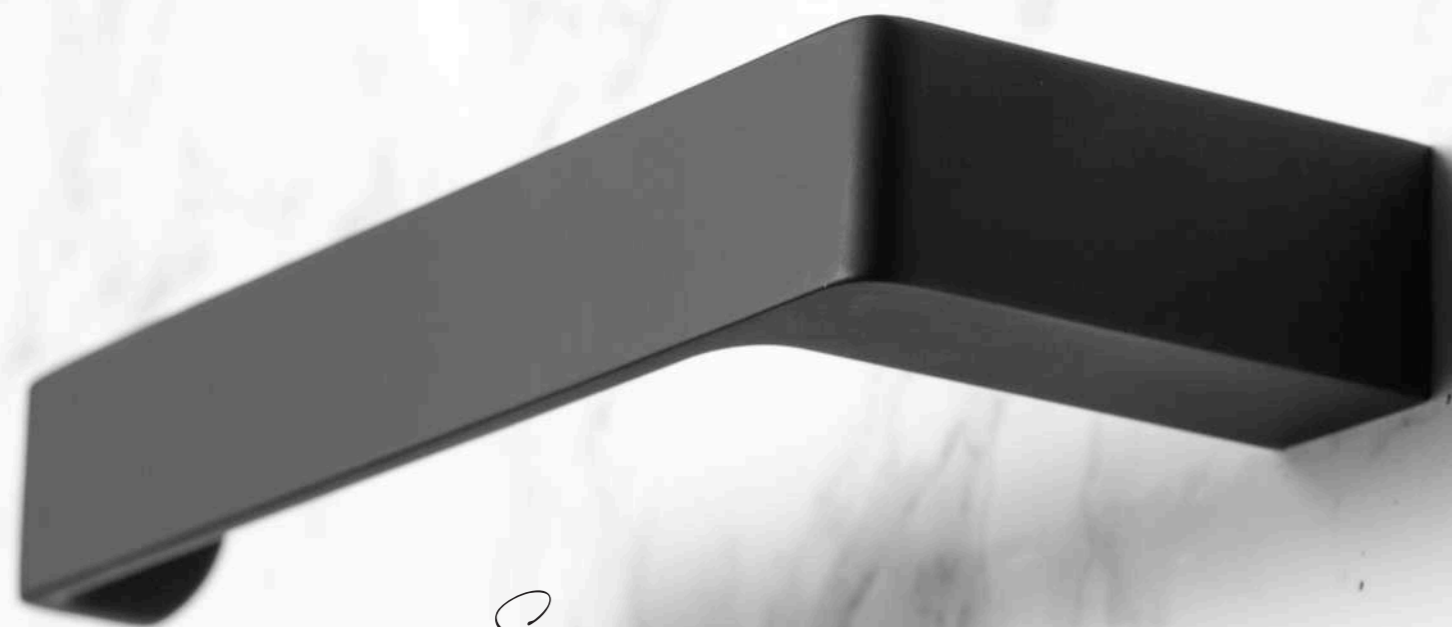

Serie
DECUA BLACK



REF. CA-30611

TOALLERO ANILLA NEGRO MATE

Towel ring
Porte-serviettes ring
Toalheiro de anel

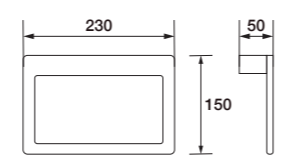

REF. CA-30615

PERCHA NEGRO MATE (2 UNIDADES)

Hanger
Cintre
Cabide

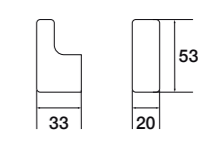

REF. CA-30612

PORTARROLLOS NEGRO MATE

Paper holder
Porte-rouleau
Porta-rolos

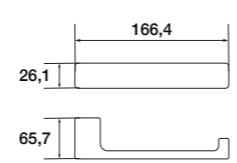

REF. CA-30616

TOALLERO BARRA NEGRO MATE 45 CM

Towel rail
Porte-serviettes droit
Toalheiro barra

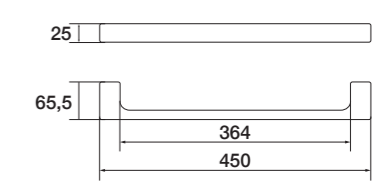

Serie
SYN



REF. CA-30601

TOALLERO ANILLA CROMO

Towel ring
Porte-serviettes ring
Toalheiro de anel

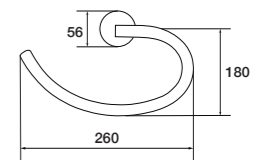

REF. CA-30602

PORTARROLLOS CROMO

Paper holder
Porte-rouleau
Porta-rolos

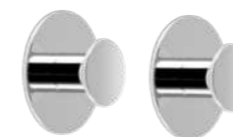
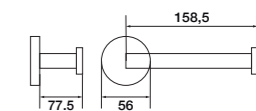

REF. CA-30605

PERCHAS CROMO (2 UNIDADES)

Hanger
Cintre
Cabide

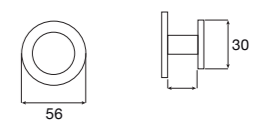

REF. CA-30604

PERCHA CROMO TRIPLE

Triple hanger
Cintre tripler
Cabide tripla

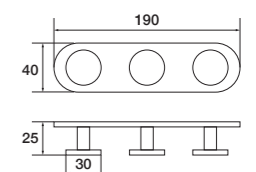

REF. CA-30606

TOALLERO BARRA CROMO 45 CM

Towel rail
Porte-serviettes droit
Toalheiro barra

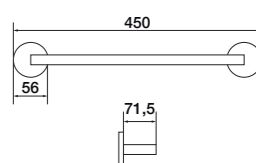

Serie
SYN BLACK



ADHESIVO / ADHESIVO / ADHESIVO
ADHESIVO
INSTALACION DUAL / DUAL INSTALLATION
TORNILLOS / SCREWS / DES VIE / PARAFUSOS



REF. CA-30701

TOALLERO ANILLA NEGRO MATE

Towel ring
Porte-serviettes ring
Toalheiro de anel

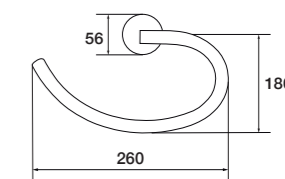

REF. CA-30702

PORTARROLLOS NEGRO MATE

Paper holder
Porte-rouleau
Porta-rolos

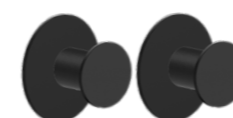
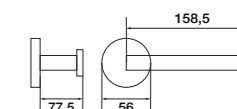

REF. CA-30705

PERCHAS NEGRO MATE (2 UNIDADES)

Hanger
Cintre
Cabide

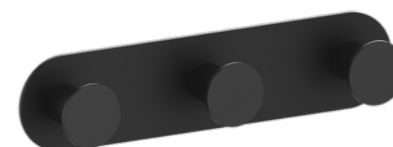
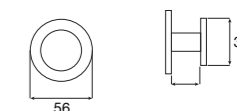

REF. CA-30704

PERCHA NEGRO MATE TRIPLE

Triple hanger
Cintre tripler
Cabide tripla

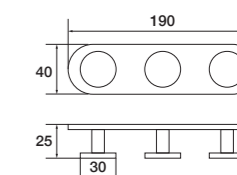

REF. CA-30706

TOALLERO BARRA NEGRO MATE 45 CM

Towel rail
Porte-serviettes droit
Toalheiro barra

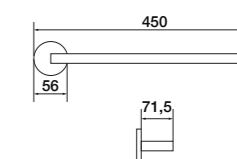

TOALLEROS Y PERCHAS



REF. CA-62681

TOALLERO PARED ACERO INOX - CROMO

Wall towel rail
Porte-serviettes mural
Toalheiro de parede

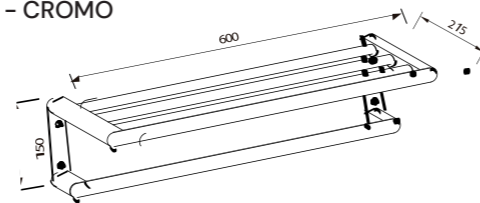

REF. CA-62682

TOALLERO PARED ACERO INOX - NEGRO MATE

Wall towel rail
Porte-serviettes mural
Toalheiro de parede

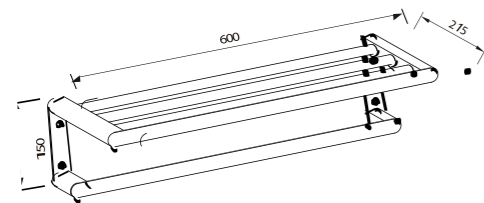

REF. CA-30270

TOALLERO CROMO

Towel rail
Porte-serviettes
Toalheiro

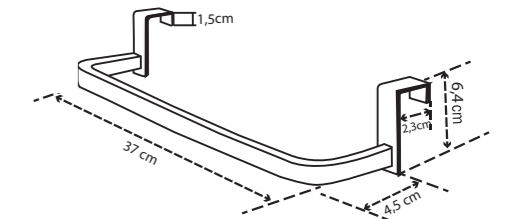

REF. CA-30271

TOALLERO NEGRO MATE

Towel rail
Porte-serviettes
Toalheiro

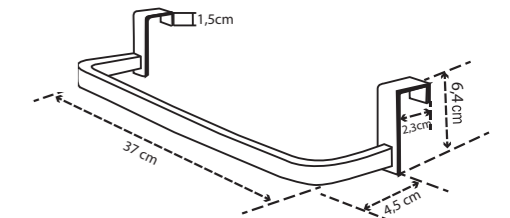

REF. CA-30275

PERCHA MAMPARA CROMO

Chrome partition hanger
Crochet de cloison chromé
Suporte de divisória cromado

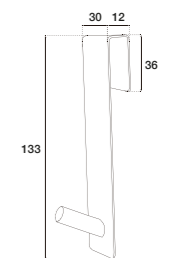

REF. CA-30276

PERCHA MAMPARA NEGRO MATE

Matt black partition hanger
Crochet de cloison noir mat
Suporte de divisória preto mate

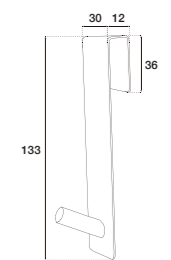

CESTAS SERIE LIME



REF. CA-62671

CESTA RECTANGULAR CROMO
Rectangular chrome basket
Panier rectangulaire chrome
Cesta rectangular cromada

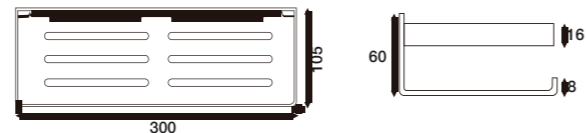

REF. CA-62672

CESTA RECTANGULAR NEGRO MATE
Rectangular matt black basket
Panier rectangulaire noir mat
Cesta rectangular preto mate

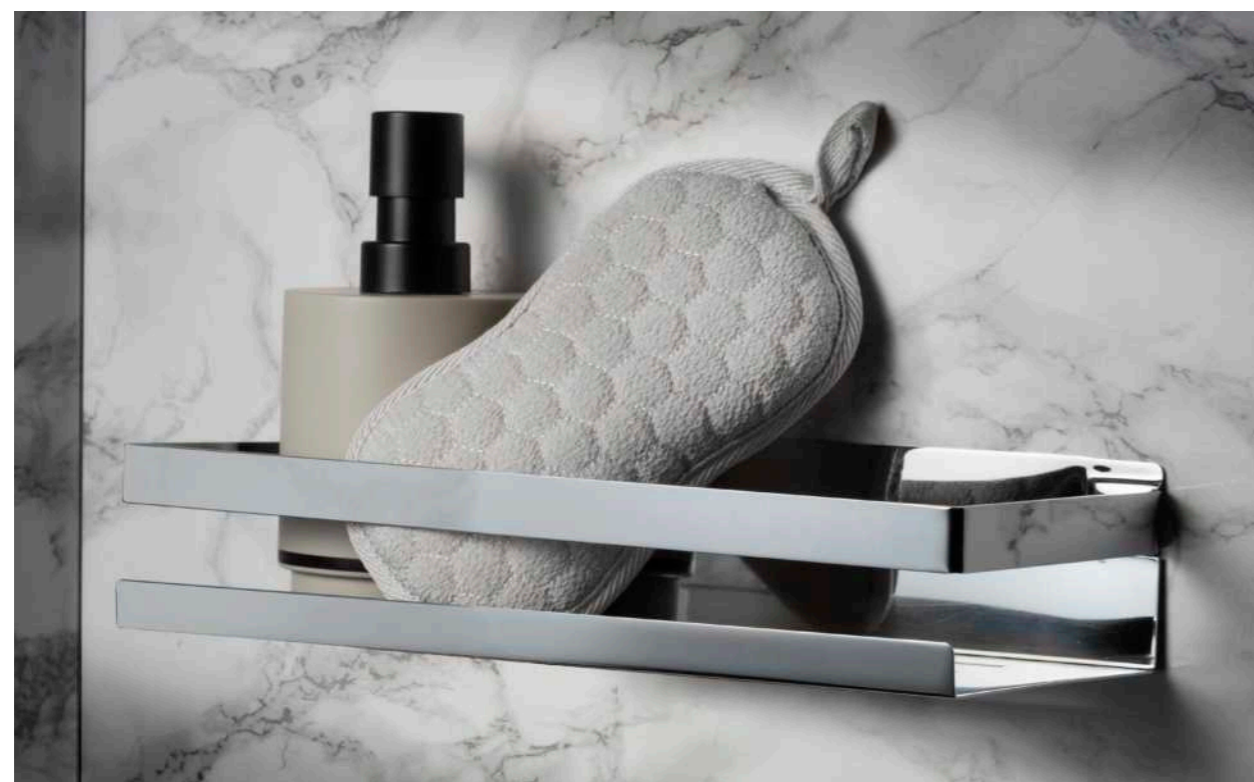
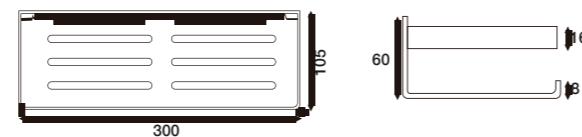

REF. CA-62673

CESTA RINCÓN CROMO
Corner chrome basket
Panier d'angle chrome
Cesta de canto cromada

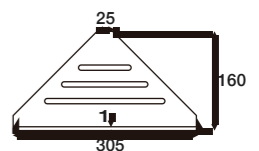

REF. CA-62674

CESTA RINCÓN NEGRO MATE
Corner matt black basket
Panier d'angle noir mat
Cesta de canto preto mate

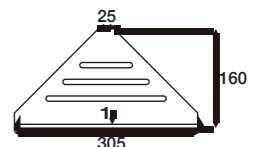

CESTAS

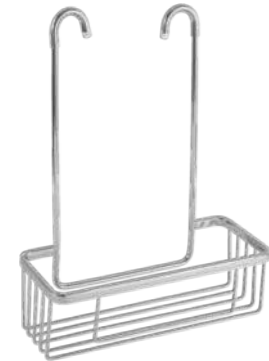

REF. CA-62598

CESTA COLGAR GRIFERÍA ALUMINIO
Basket to hang on taps
Panier à accrocher aux robinets
Cesta pendurar nas torneiras

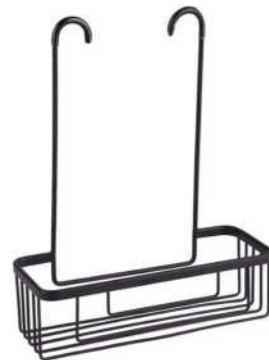
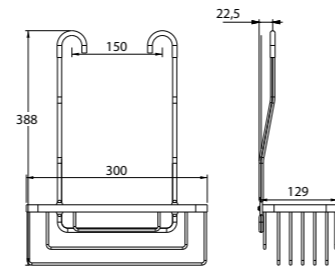

REF. CA-62599

CESTA COLGAR GRIFERÍA NEGRO MATE
Basket to hang on taps
Panier à accrocher aux robinets
Cesta pendurar nas torneiras

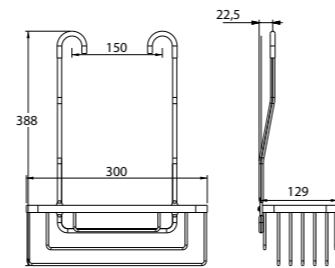

REF. CA-62593

CESTA OVALADA ACERO INOX
Oval Stainless Steel basket
Panier ovale inox
Cesta oval inox

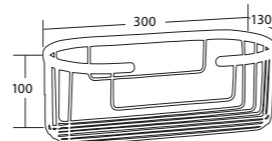

CESTA RECTANGULAR ALUMINIO

Corner matt black basket
Panier d'angle noir mat
Cesta de canto preto mate

REF. CA-62597
30 cm

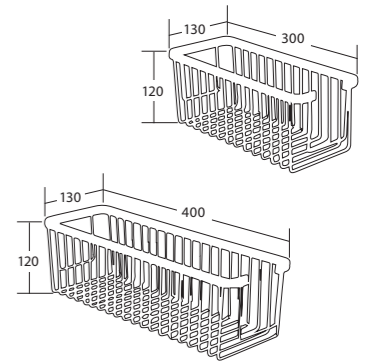

REF. CA-62596
40 cm



REF. CA-62589

CESTA RECTANGULAR NEGRO MATE
Rectangular basket
Panier rectangulaire
Cesta rectangular

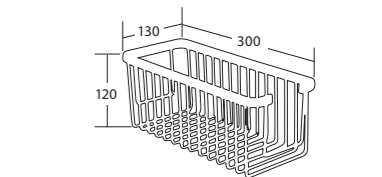

REF. CA-62595

CESTA RECTANGULAR ALUMINIO
Triangle aluminium basket
Panier triangulaire aluminium
Cesta triangular aluminio

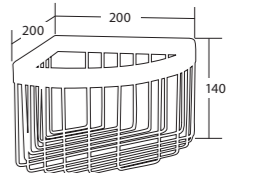

REF. CA-62591

CESTA TRIANGULAR ACERO INOX
Triangle Stainless Steel basket
Panier triangulaire laiton inox
Cesta triangular latão inox

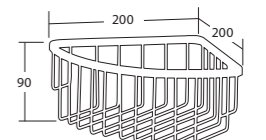

ESCOBILLEROS

SISTEMA DUAL
DUAL SYSTEM



REF. CA-62583

ESCOBILLERO DUAL CILÍNDRICO
ACERO INOX BLACK

Toilet brush holder
Porte-brosse
Porta-escova

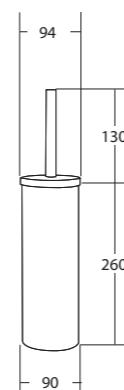

REF. CA-62508

ESCOBILLERO CILÍNDRICO ACERO INOX

Toilet brush holder
Porte-brosse
Porta-escova

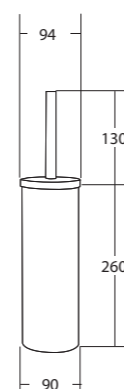

REF. CA-62580

ESCOBILLERO CUADRADO ACERO INOX

Toilet brush holder
Porte-brosse
Porta-escova

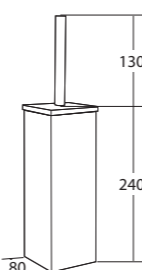

ESCOBILLERO CÓNICO

Toilet brush holder
Porte-brosse
Porta-escova



REF. 62506



REF. 62504



REF. 62507

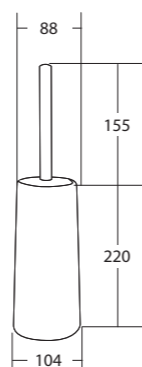

ASAS



ASA RECTA LATÓN Ø25

Straight handle
Poignée droite
Puxador reto

REF. CA-62571

25 cm

REF. CA-62573

30 cm

REF. CA-62567

40 cm

REF. CA-62568

50 cm

REF. CA-62569

60 cm

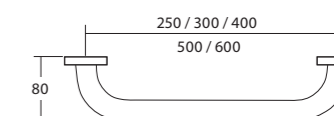

ASA RECTA LATÓN BLANCA Ø25

Straight handle
Poignée droite
Puxador reto

REF. CA-62577

25 cm

REF. CA-62578

30 cm

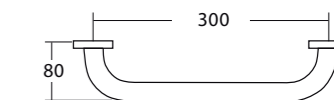

REF. CA-62572

ASA RECTA LATÓN MATE Ø25

Straight handle
Poignée droite
Puxador reto

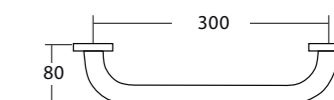

AYUDAS TÉCNICAS



REF. CA-62570

ASA RECTA LATÓN BRONCE Ø25
Straight handle
Poignée droite
Puxador reto

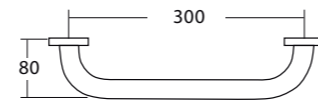

REF. 14007

BARRA APOYO ABATIBLE WC, BIDÉ, LAVABO

Folding support bar
Barre de support pliante
Barra de suporte dobrável

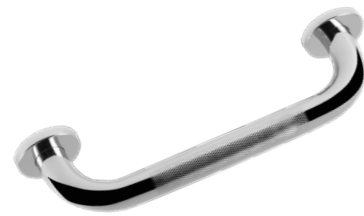
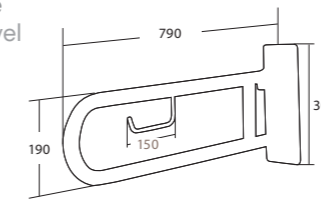

REF. CA-62574

ASA ANTIDESLIZANTE ACERO INOX
Non-slip handle
Poignée antidérapante
Alça antiderrapante

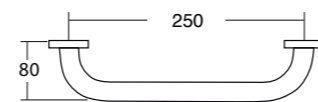

BARRA APOYO ACERO INOX BRILLO Ø32

Gloss support bar
Barre de support brillant
Barra de suporte brilho

REF. 14001
30 cm

REF. 14003
50 cm

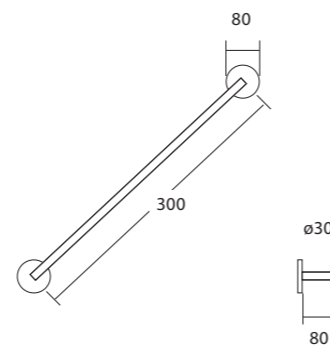

REF. 14013

BARRA APOYO ÁNGULO 90° IZQUIERDA

Left 90° angle support bar
Bare de support d'angle 90° gauche
Barra de suporte esquerda ângulo 90°

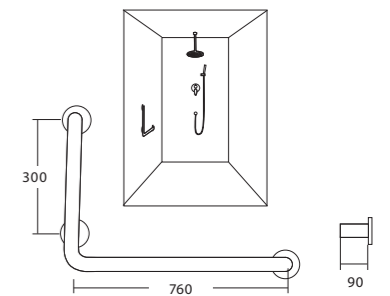

REF. 14011

BARRA APOYO ÁNGULO 90° DERECHA

Right 90° angle support bar
Bare de support d'angle 90° droite
Barra de suporte direita ângulo 90°

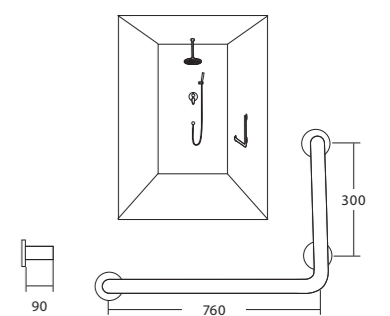

COMPLEMENTOS GRIFERÍA

BATH AND TAP COMPLEMENTS





REF. CA-41518

Ø 63

VÁLVULA CLIC-CLAC LATÓN-CROMO

Brass drain valve
Robinet vidange laiton
Válvula drenagem latão

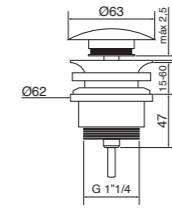

REF. CA-41519

Ø 63

VÁLVULA CLIC-CLAC LATÓN-NEGRO

Brass drain valve
Robinet vidange laiton
Válvula drenagem latão

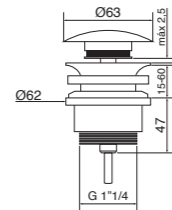

REF. CA-41545

Ø 63

VÁLVULA CLIC-CLAC LATÓN-BLANCO

Brass drain valve
Robinet vidange laiton
Válvula drenagem latão

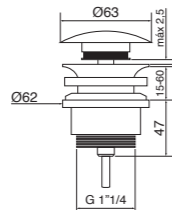

REF. CA-41517

Ø 63

VÁLVULA CLIC-CLAC LATÓN-PORCELANA

Porcelain brass drain valve
Robinet vidange laiton-porcelaine
Válvula drenagem latão-porcelana

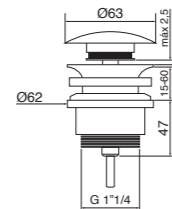

REF. CA-41526

Ø 63

VÁLVULA CLIC-CLAC LATÓN-CROMO

Brass drain valve
Robinet vidange laiton
Válvula drenagem latão

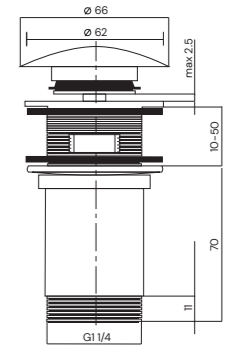

REF. CA-41521

Ø 63

VÁLVULA CLIC-CLAC PARTE SUPERIOR CROMO

ABS drain valve
Robinet vidange ABS
Válvula drenagem ABS

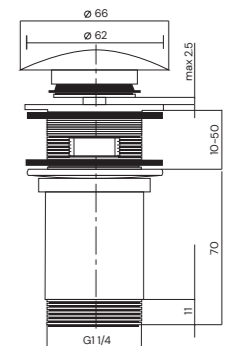

REF. CA-41524

Ø 37

VÁLVULA CLIC-CLAC LATÓN-CROMO

Brass drain valve
Robinet vidange laiton
Válvula drenagem latão

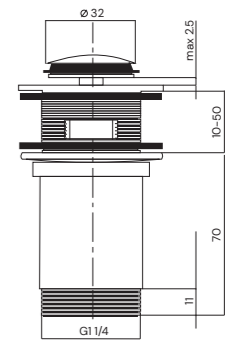

REF. CA-41528

Ø 63

VÁLVULA CLIC-CLAC LATÓN-PORCELANA

Porcelain brass drain valve
Robinet vidange laiton-porcelaine
Válvula drenagem latão-porcelana

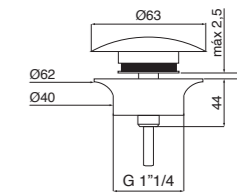



REF. CA-41430

SIFON LUX / LATÓN CROMO

Brass drain siphon
Siphon vidange laiton
Sifão drenagem latão



REF. CA-41428

SIFÓN LUX / LATÓN NEGRO

Brass drain siphon
Siphon vidange laiton
Sifão drenagem latão



REF. CA-41429

SIFÓN LUX / LATÓN BLANCO

Brass drain siphon
Siphon vidange laiton
Sifão drenagem latão



REF. CA-41435

SIFÓN LUX / ABS-CROMO

ABS drain siphon
Siphon vidange ABS
Sifão drenagem ABS



REF. CA-41432

SIFÓN BOTELLA CROMADO

Chrome drain siphon
Siphon vidange chromé
Sifão drenagem cromo



LLAVE REGULACIÓN CENTURY 1/2" x 3/8"

Adjustment key
Clé réglagé
Chave de ajuste

2 Uds.

● REF. 67008

● REF. 67006



REF. 68256

GRIFO CROMO BIDÉ VISTO (1 AGUA)

Exposed chrome bidet faucet
Robinet de bidet chromé apparent
Torneira de bidê cromada exposta

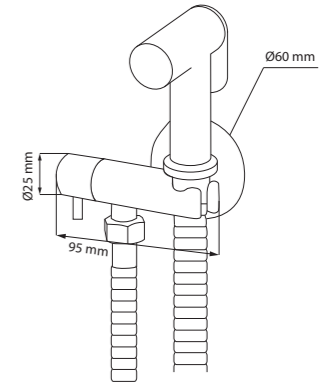

REF. 68266

GRIFO NEGRO MATE BIDÉ VISTO (1 AGUA)

Exposed matt black bidet faucet
Robinet de bidet noir mat apparent
Torneira de bidê preto mate exposta

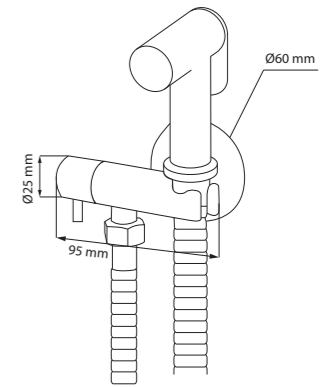

REF. 68257

MONOMANDO BIDÉ CROMO EMPOTRADO

Chrome single lever recessed bidet
Bidet encastré à leiver unique chromé
Bidé encastrado monocomando cromado

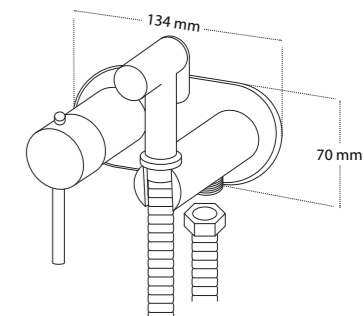

REF. 68267

MONOMANDO BIDÉ NEGRO MATE EMPOTRADO

Matt black single lever recessed bidet
Bidet encastré à leiver unique noir mat
Bidé encastrado monocomando preto mate

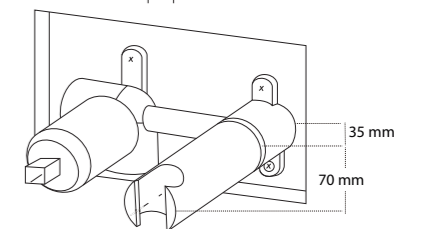

COMPLEMENTOS DUCHA

SHOWER ACCESSORIES



Complementos

ROCIADORES SLIM



SLIM REDONDO

- Ø 20 cm CA-59146
- Ø 25 cm CA-59147
- Ø 30 cm CA-59148



SLIM BLACK REDONDO

- Ø 20 cm CA-59157
- Ø 25 cm CA-59158
- Ø 30 cm CA-59159



SLIM CUADRADO

- 20x20 cm CA-59136
- 25x25 cm CA-59138
- 30x30 cm CA-59137

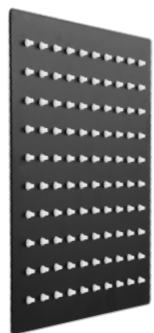

SLIM BLACK CUADRADO

- 20x20 cm CA-59160
- 25x25 cm CA-59161
- 30x30 cm CA-59162

Complementos

BRAZOS DUCHA



REF. CA-59001

30 cm

BRAZO DUCHA PARED REDONDO

Round wall shower arm
Bras douche mural rond
Braço chuveiro parede redondo



REF. CA-59004

20 cm

BRAZO DUCHA TECHO REDONDO CROMO

Round ceiling shower arm
Bras douche rond au plafond
Braço chuveiro teto redondo



REF. CA-59010

20 cm

BRAZO DUCHA TECHO REDONDO NEGRO MATE

Round ceiling shower arm
Bras douche rond au plafond
Braço chuveiro teto redondo



REF. CA-59005

20 cm

BRAZO DUCHA TECHO CUADRADO

Square ceiling shower arm
Bras douche carré au plafond
Braço chuveiro teto quadrado



REF. CA-59008

30 cm

BRAZO DUCHA PARED REDONDO NEGRO MATE

Round wall shower arm
Bras douche mural rond
Braço chuveiro parede redondo



REF. CA-59009

41 cm

BRAZO DUCHA PARED CUADRADO

Square wall shower arm
Bras douche mural carré
Braço de chuveiro parede quadrado

Sets

BARRA



REF. CA-18113

Ø28 x 60 cm

SET BARRA DUCHA LUXURY

Shower bar set
Set barre douche
Conjunto barra de chuveiro



REF. CA-18116

Ø22 x 65 cm

SET BARRA DUCHA OMEGA

Shower bar set
Set barre douche
Conjunto barra de chuveiro



REF. CA-18114

Ø22 x 65 cm

SET BARRA DUCHA BANI BLACK

Shower bar set
Set barre douche
Conjunto barra de chuveiro



Conjuntos DUCHA



REF. B-50802 Ø12
8 uds.

MANGO DUCHA BEA
Handshower
Douchette
Chuveiro



REF. CA-59155 Ø22

ROCIADOR DUCHA BEA
Shower head
Pomme douche
Lavar a cabeça



REF. B-50612 Ø12,5
8 uds.

MANGO DUCHA ESLA
Handshower
Douchette
Chuveiro



REF. CA-59146 Ø20

ROCIADOR DUCHA SLIM
Shower head
Pomme douche
Lavar a cabeça



REF. B-50642 12x14cm
6 uds.

MANGO DUCHA ARAL
Handshower
Douchette
Chuveiro



REF. CA-59152 22x25cm

ROCIADOR DUCHA ARAL
Shower head
Pomme douche
Lavar a cabeça



REF. B-50622 Ø10
10 uds.

MANGO DUCHA EYRE
Handshower
Douchette
Chuveiro



REF. CA-59153 Ø22

ROCIADOR DUCHA EYRE
Shower head
Pomme douche
Lavar a cabeça



Conjuntos DUCHA



REF. B-50212 Ø10
8 uds.

MANGO DUCHA OMEGA
Handshower
Douchette
Chuveiro



REF. CA-59154 Ø20

ROCIADOR DUCHA OMEGA
Shower head
Pomme douche
Lavar a cabeça



REF. B-50632 Ø12
8 uds.

MANGO DUCHA NYA
Handshower
Douchette
Chuveiro



REF. CA-59151 Ø22

ROCIADOR DUCHA NYA
Shower head
Pomme douche
Lavar a cabeça



REF. B-50672 Ø12
10 uds.

MANGO DUCHA BANI BLACK
Handshower
Douchette
Chuveiro



REF. CA-59156 Ø22

ROCIADOR DUCHA BANI BLACK
Shower head
Pomme douche
Lavar a cabeça



BARRAS Y SOPORTES



REF. CA-58041 65 cm

**BARRA DUCHA
BANI BLACK**

Brass shower bar
Barre douche laiton
Barra chuveiro latão



REF. CA-58017 65 cm

**BARRA DUCHA
OMEGA**

Brass shower bar
Barre douche laiton
Barra chuveiro latão



SOPORTE DUCHA S-3 6 uds.

Shower holder
Support douche
Suporte chuveiro

REF. B-57565 ●

REF. B-57566 ●

REF. B-57567 ○



REF. B-57583 8 uds.

**SOPORTE DUCHA
MILENIUM TUBI**

Shower holder
Support douche
Suporte chuveiro

FLEXOS



REF. B-55033 1,75 m

**FLEXO ACERO INOX
ANTITORSIÓN**

Anti-twist SS shoer hose
Tuyau douche inox anti-torsion
Mangueira chuveiro inox anti-torção



REF. CA-54203 1,75 m

**FLEXO PVC
LUX PLATA**

PVC shower hose
Tuyau douche PVC
Mangueira chuveiro PVC



REF. B-55121 1,5 m

**FLEXO ACERO INOX
BLACK**

SS shower hose
Flexible douche inox
Mangueira chuveiro inox



REF. B-55014 1,75 m

**FLEXO ACERO INOX
ESPIRAL MUELLE**

SS shower hose
Flexible douche inox
Mangueira chuveiro inox



FLEXO ACERO INOX

SS shower hose 10 uds.
Flexible douche inox
Mangueira chuveiro inox

REF. B-55101 1,5 m

REF. B-55103 1,75 m

REF. B-55104 2 m



REF. B-55163 1,75 m - 2,2 m

**FLEXO ACERO INOX
EXTENSIBLE**

Extendable SS shower hose
Flexible douche inox extensible
Mangueira chuveiro extensível

EXPOSITORES

DISPLAYS



Expositor

EXP1



REF. EXP1-000

180 x 50 cm

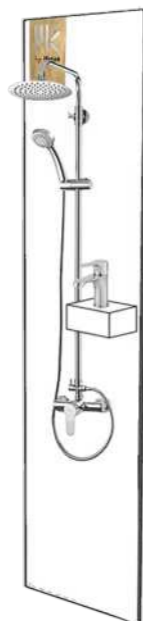

REF. EXP1-01

180 x 50 cm



REF. EXP1-100

180 x 50 cm



REF. EXP1-200

180 x 50 cm



REF. EXP1-300

180 x 50 cm

Expositor

EXP4



REF. EXP4

86 x 140 x 70 cm

Expositor

EXP5



REF. EXP5-000

6 x 30 x 30 cm

Expositor

EXP7



REF. EXP7-000

Expositor
EXP3

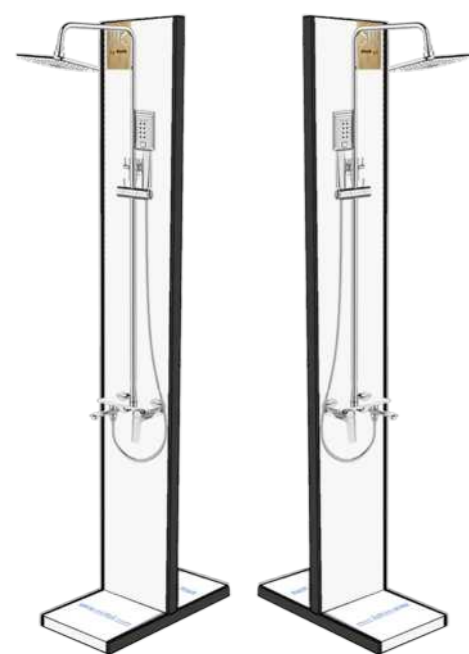

REF. EXP3-000-000
 190 x 32 x 65 cm

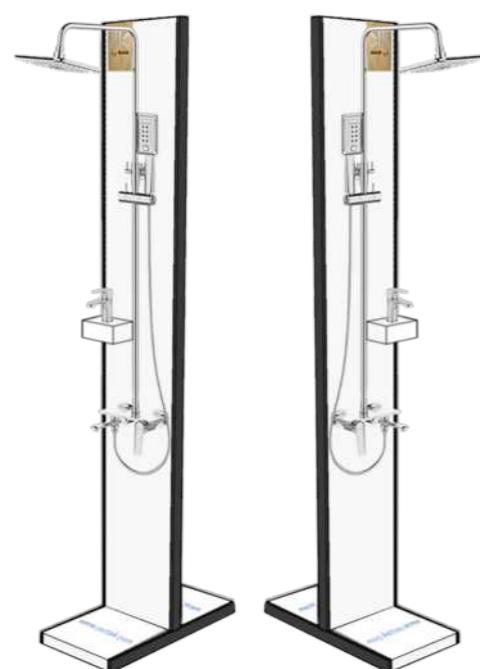

REF. EXP3-01-01
 190 x 32 x 65 cm

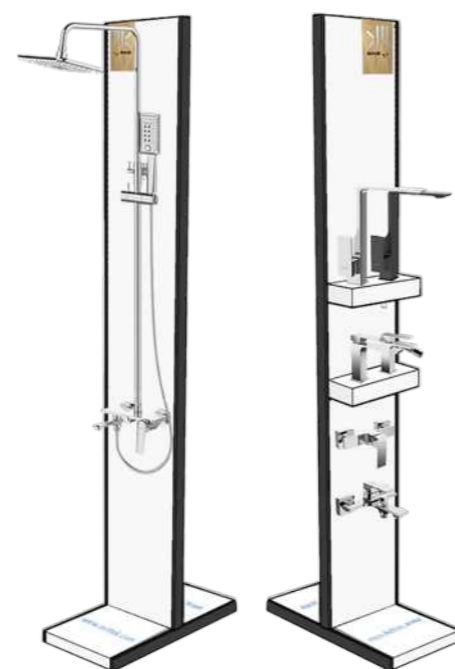

REF. EXP3-000-200
 190 x 32 x 65 cm

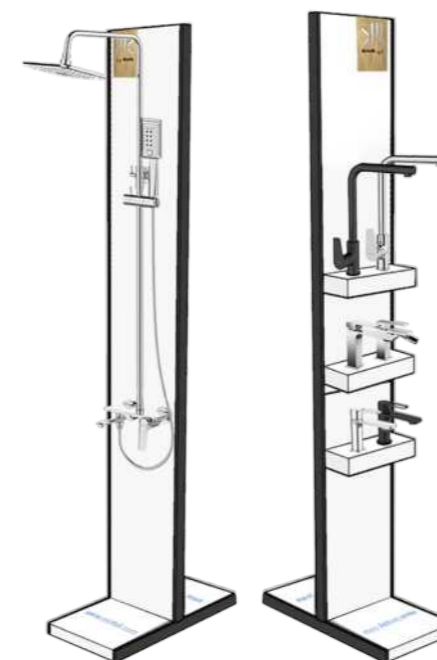

REF. EXP3-000-300
 190 x 32 x 65 cm

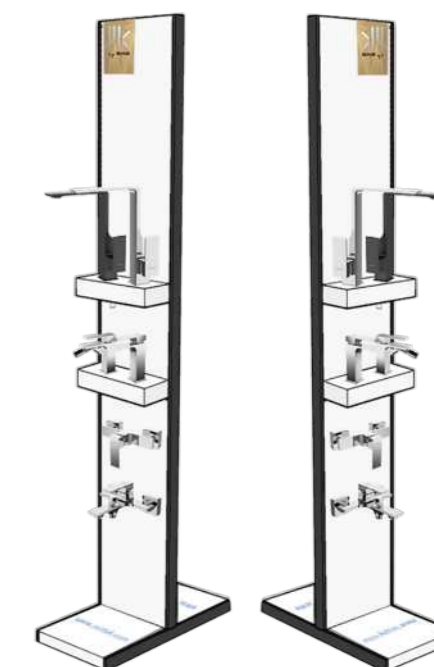

REF. EXP3-200-200
 190 x 32 x 65 cm

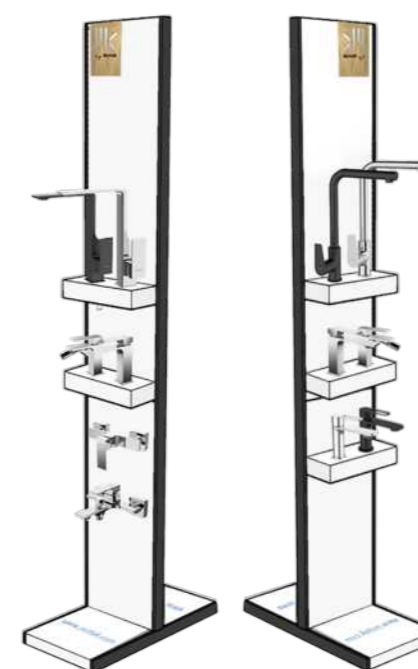

REF. EXP3-200-300
 190 x 32 x 65 cm

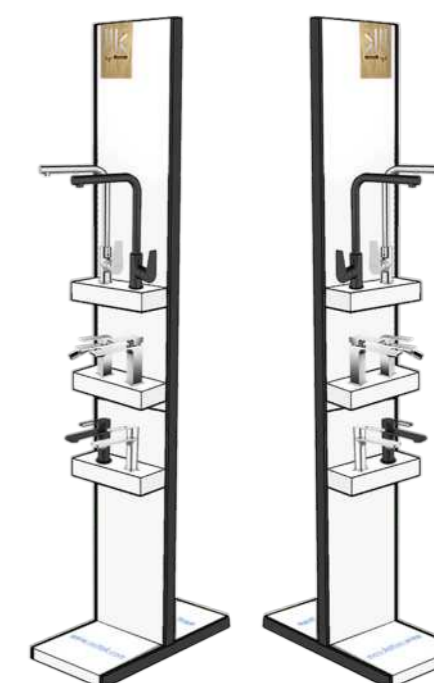

REF. EXP3-300-300
 190 x 32 x 65 cm

RECAMBIOS GRIFERÍA

MIXER REPLACEMENTS

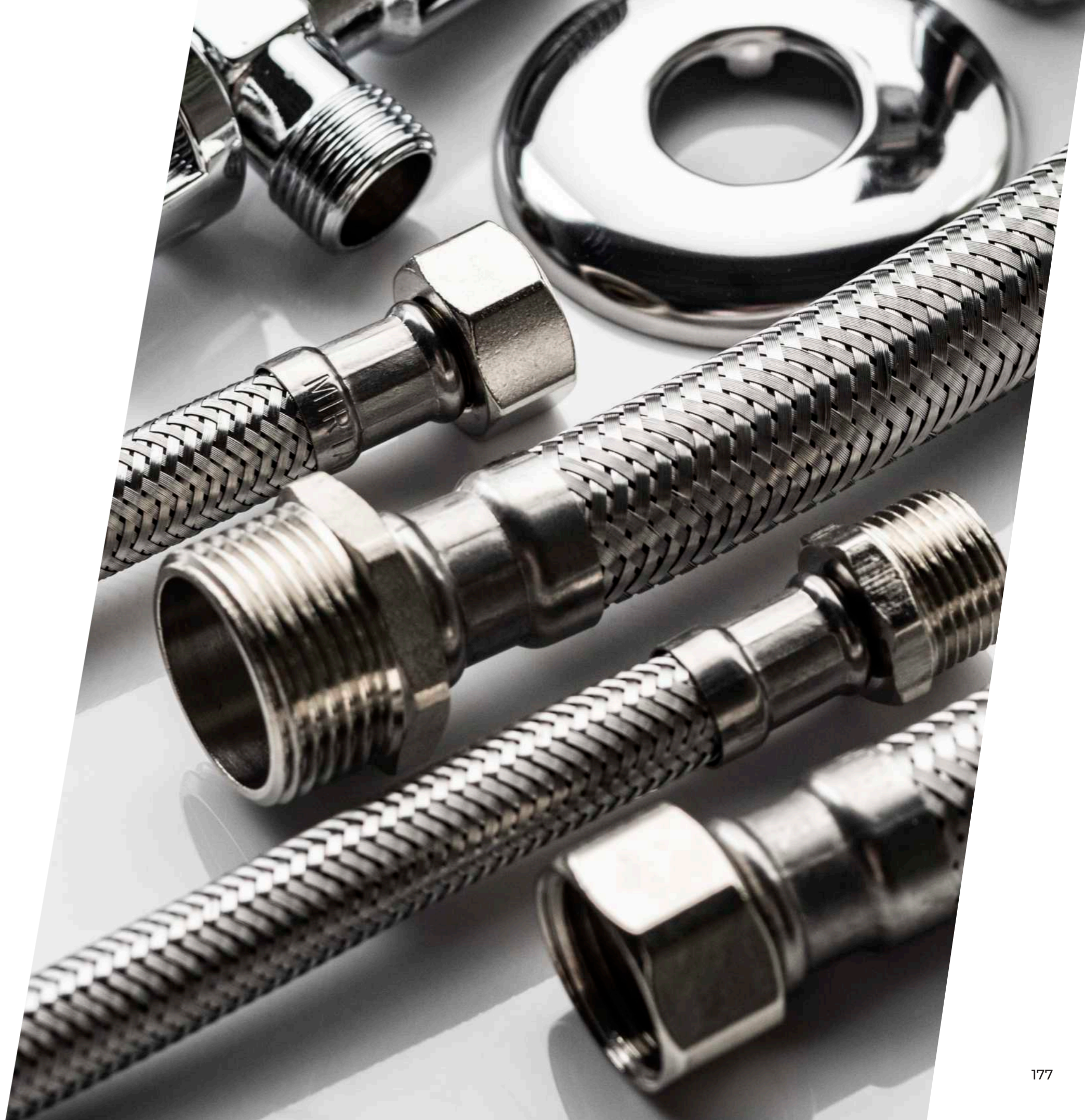



PALANCAS HANDLE

| | |
|----------|--|
| 0001.039 | MANETA SPACE 35 CROMO / Chrome handle / Poignée chromée / Alça cromada |
| 0001.031 | MANETA VOLTA BLACK 35 / Black handle / Poignée noire / Aça preto |
| 0001.019 | MANETA TENNA 35 CROMO / Chrome handle / Poignée chromée / Alça cromada |
| 0001.014 | MANETA QUADRO 35 CROMO / Chrome handle / Poignée chromée / Alça cromada |
| 0001.015 | MANETA FENIX 40 / Chrome handle / Poignée chromée / Alça cromada |
| 0001.018 | MANETA NAVY 40 / Chrome handle / Poignée chromée / Alça cromada |
| 0001.001 | MANETA CENTURY 40 / Chrome handle / Poignée chromée / Alça cromada |
| 0001.035 | POMO NEGRO SVELTA 25 / Black knob / Bouton noir / Maçaneta preto |
| 0001.036 | POMO GRIS SVELTA BLACK 25 / Grey knob / Bouton / Maçaneta |
| 0001.032 | MANETA VEGA 30 CROMO / Chrome handle / Poignée chromée / Alça cromada |
| 0001.033 | MANETA VEGA 30 INVERSA CROMO / Chrome handle / Poignée chromée / Alça cromada |
| 0001.034 | MANETA VEGA 30 NEGRA / Black handle / Poignée noire / Aça preto |
| 0001.037 | MANETA YUKON 40 CROMO / Chrome handle / Poignée chromée / Alça cromada |
| 0001.019 | MANETA TENNA 35 CROMO / Chrome handle / Poignée chromée / Alça cromada |
| 0001.020 | MANETA TENNA 35 INVERSA CROMO / Chrome handle / Poignée chromée / Alça cromada |
| 0001.038 | MANETA TENNA 35 NEGRA / Black handle / Poignée noire / Aça preto |
| 0001.028 | MANETA MAIA 26 CROMO / Chrome handle / Poignée chromée / Alça cromada |
| 0001.027 | MANETA MAIA 25 INVERSA CROMO / Chrome handle / Poignée chromée / Alça cromada |
| 0001.029 | MANETA MAIA BLACK 26 NEGRA / Black handle / Poignée noire / Aça preto |
| 0001.030 | MANETA MAIA BLACK 25 INVERSA NEGRA / Black handle / Poignée noire / Aça preto |
| 0001.016 | MANETA BEST 30 CROMO EMPOTRADO / Chrome handle / Poignée chromée / Alça cromada |
| 0001.073 | MANETA F20 INVERSA CROMO / Chrome handle / Poignée chromée / Alça cromada |
| 0001.026 | MANETA BEST 30 INVERSA CROMO / Chrome handle / Poignée chromée / Alça cromada |
| 0001.017 | MANETA CENTURY 35 CROMO / Chrome handle / Poignée chromée / Alça cromada |
| 0001.025 | MANETA CENTURY Y F13 (DERECHA) 35 INVERSA CROMO / Chrome handle / Poignée chromée / Alça cromada |
| 0001.023 | MANETA NEVA 35 CROMO / Chrome handle / Poignée chromée / Alça cromada |
| 0001.024 | MANETA NEVA 35 INVERSA CROMO / Chrome handle / Poignée chromée / Alça cromada |
| 0001.021 | MANETA NAVY 35 CROMO / Chrome handle / Poignée chromée / Alça cromada |
| 0001.022 | MANETA NAVY 35 INVERSA CROMO / Chrome handle / Poignée chromée / Alça cromada |
| 0001.012 | MANETA OASIS 40 CROMO / Chrome handle / Poignée chromée / Alça cromada |
| 0001.011 | MANETA OASIS 40 INVERSA CROMO / Chrome handle / Poignée chromée / Alça cromada |
| 0001.010 | MANETA OASIS 40 INVERSA BLANCA / White handle / Poignée blanc / Alça branco |
| 0001.009 | MANETA OASIS 40 INVERSA TIERRA FRANCIA / Brown handle / Poignée Terre France / Alça castanho |
| 0001.008 | MANETA MEDICAL 40 CROMO / Chrome handle / Poignée chromée / Alça cromada |
| 0001.007 | MANETA MEDICAL FRONTAL / Chrome handle / Poignée chromée / Alça cromada |
| 0001.006 | MANETA F8 Y F9 INVERSA CROMO / Chrome handle / Poignée chromée / Alça cromada |
| 0001.005 | MANETA F14 INVERSA CROMO / Chrome handle / Poignée chromée / Alça cromada |
| 0001.004 | MANETA F13 IZQUIERDA CROMO / Chrome handle / Poignée chromée / Alça cromada |
| 0001.074 | MANETA F23 INVERSA NEGRA / Black handle / Poignée noir / Alça preto |
| 0001.046 | MANETA MAIA 35 / Chrome handle / Poignée chromée / Alça cromada |
| 0001.047 | MANETA MAIA BLACK 35 / Black handle / Poignée noire / Alça preto |
| 0001.050 | POMO NEGRO SVELTA 35 / Black knob / Bouton noir / Maçaneta preto |
| 0001.051 | POMO GRIS SVELTA BLACK 35 / Grey knob / Bouton / Maçaneta |
| 0001.041 | MANETA MAIA 26 ORO DARK / Dark gold handle / Poignée or foncé / Alça ouro escuro |
| 0001.043 | MANETA MAIA 25 ORO DARK / Dark gold handle / Poignée or foncé / Alça ouro escuro |
| 0001.042 | MANETA MAIA 35 ORO DARK / Dark gold handle / Poignée or foncé / Alça ouro escuro |
| 0001.048 | MANETA ERA 26 / Chrome handle / Poignée chromée / Alça cromada |
| 0001.049 | MANETA ERA 35 / Chrome handle / Poignée chromée / Alça cromada |
| 0001.072 | POMO PRESS 26 (BIDÉ) / Chrome knob / Bouton chromée / Maçaneta cromada |
| 0001.069 | POMO PRESS 35 / Chrome knob / Bouton chromée / Maçaneta cromada |

| | |
|----------|--|
| 0001.052 | MANETA ERA BLACK 26 / Black handle / Poignée noir / Alça preto |
| 0001.053 | MANETA ERA BLACK 35 / Black handle / Poignée noir / Alça preto |
| 0001.067 | VOLANTE VITA 26 / Chrome handle / Poignée chromée / Alça cromada |
| 0001.068 | VOLANTE VITA 35 / Chrome handle / Poignée chromée / Alça cromada |
| 0001.070 | VOLANTE VITA BLACK 26 / Black handle / Poignée noir / Alça preto |
| 0001.071 | MANETA VITA BLACK 35 / Black handle / Poignée noir / Alça preto |
| 0001.063 | POMO QUO BLANCO 26 / White marmol knob / Bouton marbre blanc / Maçaneta marmore branco |
| 0001.064 | POMO QUO BLANCO 35 / White marmol knob / Bouton marbre blanc / Maçaneta marmore branco |
| 0001.061 | POMO QUO NEGRO 26 / Black marmol knob / Bouton marbre noir / Maçaneta marmore preto |
| 0001.062 | POMO QUO NEGRO 35 / Black marmol knob / Bouton marbre noir / Maçaneta marmore preto |
| 0001.065 | POMO PLATINUM N 26 / Chrome knob / Bouton chremée / Maçaneta cromado |
| 0001.066 | POMO PLATINUM N 35 / Chrome knob / Bouton chremée / Maçaneta cromado |
| 0001.054 | MANETA NEVA BLACK 35 / Chrome handle / Poignée chremée / Alça cromado |
| 0001.055 | MANETA NEVA BLACK INVERSA 35 / Chrome handle / Poignée chremée / Alça cromado |



VOLANTE TERMOSTÁTICO THERMOSTATIC HANDLE

| | |
|----------|--|
| 0001.090 | SQ-77 KIT VOLANTE DERECHO COLUMNNA TERMOSTÁTICA / Handgrip thermostatic / volant thermostatique / volante termostático |
| 0001.092 | VULKAN KIT VOLANTE DERECHO COLUMNNA TERMOSTÁTICA / Handgrip thermostatic / volant thermostatique / volante termostático |
| 0001.093 | MAXI-2 KIT VOLANTE DERECHO TERMOSTÁTICA / Handgrip thermostatic kit / kit volant thermostatique / kit volante termostático |
| 0001.089 | SQ-77 VOLANTE IZQUIERDO / Handgrip thermostatic kit / kit volant thermostatique / kit volante termostático |
| 0001.091 | VULKAN VOLANTE IZQUIERDO / Handgrip thermostatic / volant thermostatique / volante termostático |
| 0001.094 | MAXI-2 VOLANTE IZQUIERDO / Thermostatic handgrip / volant thermostatique / volante termostático |



VOLANTE BIMANDO TWO-HANDLE HANDLE

| | |
|----------|--|
| 0001.080 | STILO VOLANTE CROMO / Chrome handgrip / Volant chromée / Volante cromada |
| 0001.086 | BASIC VOLANTE CROMO ROJO / Chrome-red handgrip / Volant chromée-rouge / Volante cromada-vermelho |
| 0001.087 | BASIC VOLANTE CROMO AZUL / Chrome-blue handgrip / Volant chromée-bleu / Volante cromada-azul |



CARTUCHO CARTRIDGE

| | |
|----------|---|
| 0001.145 | Ø25A CARTUCHO MONOMANDO / Single lever cartridge / Cartouche mitigeur / Cartucho monocomando |
| 0001.144 | Ø30A CARTUCHO MONOMANDO / Single lever cartridge / Cartouche mitigeur / Cartucho monocomando |
| 0001.154 | Ø35A CARTUCHO MONOMANDO / Single lever cartridge / Cartouche mitigeur / Cartucho monocomando |
| 0001.143 | Ø35A DOBLE APERTURA CARTUCHO MONOMANDO / Single lever cartridge / Cartouche mitigeur / Cartucho monocomando |
| 0001.141 | Ø35A ECO CARTUCHO MONOMANDO / Single lever cartridge / Cartouche mitigeur / Cartucho monocomando |
| 0001.150 | Ø40A CARTUCHO MONOMANDO / Single lever cartridge / Cartouche mitigeur / Cartucho monocomando |
| 0001.142 | Ø40A DOBLE APERTURA CARTUCHO MONOMANDO / Single lever cartridge / Cartouche mitigeur / Cartucho monocomando |
| 0001.140 | Ø40A ECO CARTUCHO MONOMANDO / Single lever cartridge / Cartouche mitigeur / Cartucho monocomando |
| 0001.148 | Ø35B CARTUCHO MONOMANDO / Single lever cartridge / Cartouche mitigeur / Cartucho monocomando |
| 0001.156 | Ø18 CARTUCHO TERMOSTÁTICO SQ-77 / Thermostatic cartridge / Cartouche thermostatique / Cartucho termostático |
| 0001.153 | Ø30 CARTUCHO TERMOSTÁTICO / Thermostatic cartridge / Cartouche thermostatique / Cartucho termostático |
| 0001.155 | CARTUCHO TEMPORIZADO EMPOTRADOS / Timer tap cartridge / Cartouche temporisé / Cartucho temporizador |
| 0001.157 | CARTUCHO TEMPORIZADO T1 & T2 / Timer tap cartridge / Cartouche temporisé / Cartucho temporizador |
| 0001.158 | CARTUCHO TEMPORIZADO SENCILLO / Timer tap cartridge / Cartouche temporisé / Cartucho temporizador |



ATOMIZADOR INTERNO INTERNAL AERATOR

| | |
|-------|--|
| 60345 | SLINE-M24 + LLAVE / Aerator with key / Aérateur + clé / Aerador + chave |
| 60346 | SLINE-M21.5 + LLAVE / Aerator with key / Aérateur + clé / Aerador + chave |
| 60347 | SLINE-M18.5 + LLAVE / Aerator with key / Aérateur + clé / Aerador + chave |
| 60344 | M18.5 + LLAVE ORIGINAL / Aerator with key / Aérateur + clé / Aerador + chave |
| 60342 | M24 + LLAVE ORIGINAL / Aerator with key / Aérateur + clé / Aerador + chave |
| 60343 | M21.5 + LLAVE ORIGINAL / Aerator with key / Aérateur + clé / Aerador + chave |

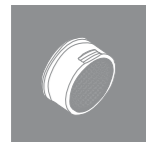
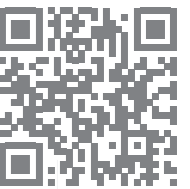

ATOMIZADOR EXTERNO
EXTERNAL AERATOR

| | |
|-------|---|
| 60301 | M28 X 100 / Aerator / Áérateur / Aerador |
| 60349 | H26 X 100 STILO / Aerator / Áérateur / Aerador |
| 60300 | M24 X 100 / Aerator / Áérateur / Aerador |
| 60304 | M24 X 100 ECO / Aerator / Áérateur / Aerador |
| 60339 | H20 X 100 BIDÉ / Aerator / Áérateur / Aerador |
| 60302 | H22 X 100 / Aerator / Áérateur / Aerador |
| 60305 | H22 X 100 ECO / Aerator / Áérateur / Aerador |
| 60360 | LLAVE ATOMIZADORES EXTERNOS / External key / Clé externe / Chave externa |
| 60338 | RÓTULA + ATOMIZADOR BIDÉS MAIA, SVELTA, YUKON, VEGA / Chrome ball joint / Rotule chromée / Junta esférica |
| 60337 | RÓTULA NEGRA + ATOMIZADOR BIDÉS MAIA Y SVELTA BLACK / Black ball joint / Rotule noir / Junta esférica |
| 60310 | RÓTULA NAVY, NEVA, OASIS, BEST, CENTURY, STILO / Chrome ball joint / Rotule chromée / Junta esférica |
| 60337 | RÓTULA BIDÉ TENNA / Chrome ball joint / Rotule chromée / Junta esférica |
| 60340 | F13 OSMOSIS M18 X 100 / Aerator / Áérateur / Aerador |

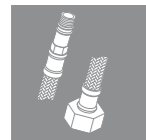

CONEXIONES
HOSES

| | |
|-------|---|
| 11931 | 30 CM NIPEL 7 CM M 9X100 - F 3/8" / Hoses / Connexions / Conexões |
| 11930 | 35 CM NIPEL 2 CM M 10X100 - F 3/8" / Hoses / Connexions / Conexões |
| 11920 | 35 CM NIPEL 2 CM M 8X100 - F 3/8" / Hoses / Connexions / Conexões |
| 11940 | 40 CM NIPEL 2 CM M 10X100 - F 3/8" / Hoses / Connexions / Conexões |
| 11943 | 40 CM NIPEL 7 CM M 10X100 - F 3/8" / Hoses / Connexions / Conexões |
| 11945 | 45 CM NIPEL 2 CM M 10X100 - F 3/8" / Hoses / Connexions / Conexões |
| 11915 | 15 CM M 10X100 - F 15X100 PARA EXTRAÍBLE / Hose / Connexion / Conexõe |
| 11960 | 60 CM NIPEL 2 CM M 100X10 - F 1/2" / Hose / Connexion / Conexõe |



BASE
LOW BASE

| | |
|----------|--|
| 0001.230 | REDONDA LATÓN CROMO / Brass base / Base laiton / Base latão |
| 0001.231 | REDONDA LATÓN NEGRA / Brass base / Base laiton / Base latão |
| 0001.232 | CUADRADA LATÓN CROMO / Brass base / Base laiton / Base latão |
| 0001.233 | CUADRADA LATÓN NEGRA / Brass base / Base laiton / Base latão |



FIJACIÓN
FIXING SYSTEM

| | |
|----------|---|
| 0001.240 | "EASY FIX" 25 |
| 0001.241 | "EASY FIX" 30 |
| 0001.242 | "EASY FIX" 35 |
| 0001.243 | "EASY FIX" 40 |
| 0001.244 | JUEGO SUJECIÓN 1 TORNILLO / 1 Screw / 1 Vis / 1 Parafuso |
| 0001.245 | JUEGO SUJECIÓN 2 TORNILLOS / 2 Screws / 2 Vis / 2 Parafusos |



MONTURAS
HEADWORK

| | |
|----------|---|
| 0001.110 | VULKAN MONTURA TERMOSTÁTICA / Thermostatic headwork / Monture thermostatique / Monte termostático |
| 0001.109 | SQ-77 MONTURA TERMOSTÁTICA / Thermostatic headwork / Monture thermostatique / Monte termostático |
| 0001.108 | MAXI-2 MONTURA TERMOSTÁTICA / Thermostatic headwork / Monture thermostatique / Monte termostático |
| 0001.106 | STILO MONTURA SERIE Y COLUMNA / Conventional headwork / Monture conventionnel / Monte convencional |
| 0001.105 | OSMOSIS F14 PARTE DELANTERA CAÑO / Osmosis headwork / Monture Osmosis / Monte osmosis |
| 0001.101 | OSMOSIS F13 MANETA / Osmosis headwork / Monture Osmosis / Monte osmosis |
| 0001.103 | BASIC SERIE / Conventional headwork / Monture conventionnel / Monte convencional |
| 0001.100 | STANDARD MONTURA TERMOSTÁTICA / Thermostatic headwork / Monture thermostatique / Monte termostático |
| 0001.104 | SQUARE MONTURA TERMOSTÁTICA / Thermostatic headwork / Monture thermostatique / Monte termostático |



CAÑO
SPOUT

| | |
|----------|--|
| 0001.187 | 22CM CAÑO HORIZONTAL BATERIA / horizontal spout / Bec horizontal / Bico horizontal |
| 0001.185 | 18CM CAÑO HORIZONTAL BATERIA / horizontal spout / Bec horizontal / Bico horizontal |
| 0001.190 | 22CM CAÑO VERTICAL BATERIA / Vertical spout / Bec vertical / Bico vertical |
| 0001.188 | 22CM CAÑO VERTICAL GIRATORIO / vertical spout / Bec vertical / Bico vertical |
| 0001.189 | 22CM CAÑO HORIZONTAL GIRATORIO / Horizontal spout / Bec horizontal / Bico horizontal |
| 0001.186 | SPACE BAÑO COLUMNA DUCHA / Bath spout / Bec baignoire / Bico banho |



FLORÓN
PLATE

| | |
|----------|---|
| 0001.203 | 25 CROMO / Chrome / Chrome / Cromada |
| 0001.204 | 25 NEGRO / Black / Noir / Preto |
| 0001.205 | 30 CROMO / Chrome / Chrome / Cromada |
| 0001.206 | 30 NEGRO / Black / Noir / Preto |
| 0001.207 | 35 CROMO / Chrome / Chrome / Cromada |
| 0001.208 | 35 NEGRO / Black / Noir / Preto |
| 0001.209 | 40 CROMO / Chrome / Chrome / Cromada |
| 0001.210 | ESPECIAL 40 CROMO / Chrome / Chrome / Cromada |
| 0001.201 | FLORON PARED DE 1/2 / Chrome / Chrome / Cromada |
| 0001.211 | FLORÓN STILO / Chrome / Chrome / Cromada |
| 0001.212 | FLORÓN SQ-77 / Chrome / Chrome / Cromada |



EXCÉNTRICAS
ECCENTRIC SET

| | |
|-------|--|
| 65702 | 1/2 X 3/4 X 10 REDONDOS PLANOS CROMO / Round chrome / Rond chrome / Volta cromada |
| 65703 | 1/2 X 3/4 X 10 REDONDOS PLANOS NEGRO / Round black / Rond Noir / Volta Preto |
| 65704 | 1/2 X 3/4 X 10 CUADRADOS CROMO / Square chrome / Carrés chrome / Quadrados cromada |
| 65700 | 1/2 X 3/4 X 10 REDONDOS EMBUDO CROMO / Round chrome / Rond chrome / Volta cromada |
| 65701 | 1/2 X 3/4 X 20 EXCÉNTRICAS SUPER / Round chrome / Rond chrome / Volta cromada |



INVERSORES
DIVERTERS

| | |
|----------|---|
| 0001.400 | COLUMNA REDONDA CROMO / Shower column / Colonne douche / Coluna chuveiro |
| 0001.401 | COLUMNA CUADRADA CROMO / Shower column / Colonne douche / Coluna chuveiro |
| 0001.402 | MAIA BAÑO CROMO / Chrome / Chrome / Cromada |
| 0001.403 | MAIA BAÑO NEGRO / Black / Noir / Preto |
| 0001.404 | VEGA BAÑO CROMO / Chrome / Chrome / Cromada |
| 0001.405 | YUKON BAÑO CROMO / Chrome / Chrome / Cromada |
| 0001.406 | TENNA BAÑO CROMO / Chrome / Chrome / Cromada |
| 0001.407 | BEST BAÑO CROMO / Chrome / Chrome / Cromada |
| 0001.408 | CENTURY BAÑO CROMO / Chrome / Chrome / Cromada |
| 0001.409 | DISTRIBUIDOR GRUPO BAÑO COMPLETO / Chrome / Chrome / Cromada |
| 0001.410 | NEVA BAÑO CROMO / Chrome / Chrome / Cromada |
| 0001.411 | NAVY BAÑO CROMO / Chrome / Chrome / Cromada |
| 0001.412 | OASIS BAÑO CROMO / Chrome / Chrome / Cromada |
| 0001.413 | BEST EMPOTRADO / Chrome / Chrome / Cromada |
| 0001.414 | CENTURY EMPOTRADO / Chrome / Chrome / Cromada |
| 0001.415 | SQUARE TERMOSTÁTICA BAÑO / Chrome / Chrome / Cromada |

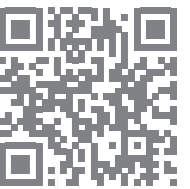

MANGO SHOWER HANDLE

| | |
|-------|--|
| 51302 | MANGO DUCHA SPACE / Handshower / Douchette / Chuveiro |
| 50672 | MANGO DUCHA BANI BLACK / Handshower / Douchette / Chuveiro |
| 52502 | MANGO DUCHA VERO / Handshower / Douchette / Chuveiro |
| 50513 | MANGO TUBI BLACK / Handshower / Douchette / Chuveiro |
| 50512 | MANGO TUBI CROMO / Handshower / Douchette / Chuveiro |
| 51303 | MANGO ERA / Handshower / Douchette / Chuveiro |
| 51304 | MANGO ERA BLACK / Handshower / Douchette / Chuveiro |
| 50521 | MANGO NERVION CROMO / Handshower / Douchette / Chuveiro |
| 50520 | MANGO NERVION BLACK / Handshower / Douchette / Chuveiro |
| 51802 | MANGO EXTRAÍBLE LUNA - OASIS / Handshower / Douchette / Chuveiro |
| 51702 | MANGO EXTRAÍBLE F20 / Handshower / Douchette / Chuveiro |
| 51502 | MANGO F9 (MUELLE) / Handshower / Douchette / Chuveiro |



FLEXO SHOWER HOSE

| | |
|-------|--|
| 55103 | ACERO INOX 1.75 M / SS shower hose / Flexible douche inox / Mangueira chuveiro inox |
| 55123 | ACERO INOX BLACK 1.75 M / SS Black shower hose / Flexible douche inox noir / Mangueira chuveiro inox preto |
| 56302 | ACERO INOX EXTRAÍBLE 1.20 M OASIS / SS sink hose / Flexible inox / Mangueira inox |
| 56304 | ACERO INOX EXTRAÍBLE F20 / SS sink hose / Flexible inox / Mangueira inox |

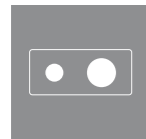

PLACA EMPOTRADOS BUILT-IN COVER

| | |
|----------|---|
| 0001.218 | PLACA CROMO RECTANGULAR / Chrome plate / Plaque chromée / Placa cromada |
| 0001.219 | PLACA NEGRO MATE RECTANGULAR / Matt black plate / Plaque noir / Placa preto |



SOPORTE DUCHA SHOWER HOLDER

| | |
|----------|---|
| 57583 | SOPORTE MILENIUM TUBI / Shower holder / Support douche / Suporte chuveiro |
| 0001.422 | SOPORTE COLUMNAS NEGRAS REDONDO / Shower holder / Support douche / Suporte chuveiro |
| 0001.420 | SOPORTE COLUMNAS REDONDAS CROMO / Shower holder / Support douche / Suporte chuveiro |
| 0001.423 | SOPORTE COLUMNA QUADRO / Shower holder / Support douche / Suporte chuveiro |
| 0001.424 | SOPORTE COLUMNA SQ-77 / Shower holder / Support douche / Suporte chuveiro |
| 57565 | SOPORTE S-3 / Shower holder / Support douche / Suporte chuveiro |
| 57566 | SOPORTE S-3 BLACK / Shower holder / Support douche / Suporte chuveiro |
| 57522 | SOPORTE COMBI / Shower holder / Support douche / Suporte chuveiro |

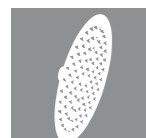

ROCIADOR SHOWER HEAD

| | |
|----------|---|
| CA-59163 | ROCIADOR SPACE / Shower head / Pomme douche / Lavar a cabeça |
| CA-59149 | Ø20 CM SLIM BLACK / Shower head / Pomme douche / Lavar a cabeça |
| CA-59146 | Ø20 CM SLIM REDONDO / Shower head / Pomme douche / Lavar a cabeça |
| CA-59136 | 20 CM SLIM CUADRADO / Shower head / Pomme douche / Lavar a cabeça |
| CA-59152 | ROCIADOR ARAL / Shower head / Pomme douche / Lavar a cabeça |

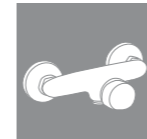

CUERPO BODY

| | |
|----------|---|
| 0001.450 | CUERPO COLUMNA TENNA / Shower column body / Corp colonne douche / Corpo coluna chuveiro |
| 0001.451 | CUERPO COLUMNA CENTURY / Shower column body / Corp colonne douche / Corpo coluna chuveiro |
| 0001.452 | CUERPO COLUMNA QUADRO / Shower column body / Corp colonne douche / Corpo coluna chuveiro |
| 0001.453 | CUERPO COLUMNA NAVY / Shower column body / Corp colonne douche / Corpo coluna chuveiro |
| 0001.454 | CUERPO COLUMNA ARAL / Shower column body / Corp colonne douche / Corpo coluna chuveiro |
| 0001.455 | CUERPO COLUMNA MAXI / Shower column body / Corp colonne douche / Corpo coluna chuveiro |
| 0001.456 | CUERPO COLUMNA MAXI-2 / Shower column body / Corp colonne douche / Corpo coluna chuveiro |
| 0001.457 | CUERPO COLUMNA STILO / Shower column body / Corp colonne douche / Corpo coluna chuveiro |

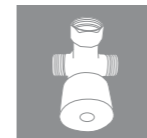

LLAVE AJUSTE TEMP. TEMPERATURE KEY

| | |
|-------|---|
| 65852 | LLAVE 3 VÍAS 1/2 ELECTRÓNICO / Temperature key / Touche température / Chave temperatura |
|-------|---|



TRANSFORM. TRANSFORMER

| | |
|-------|---|
| 65850 | 6V. O 220V STAR TRANSFORMADOR GRIFO LECTRÓNICO / Transformer / Transformateur / Transformador |
| 65853 | 6V. ERGO TRANSFORMADOR GRIFO LECTRÓNICO PILAS / Transformer / Transformateur / Transformador |

CONDICIONES GENERALES DE VENTA

PRECIOS

Sujetos a cualquier variación según las condiciones de mercado: los precios no incluyen IVA. Esta Tarifa de Precios anula la anterior y deja sin efecto a las anteriores.

FORMAS DE PAGO

Se efectuará un máximo de giro a 45 días fecha factura.

El importe del pedido mínimo para giro será de 150, independientemente de la forma de pago habitual, los giros inferiores a este importe originarán un solo vencimiento.

Las condiciones de pago indicadas en factura son obligatorias, cada variación que no haya sido previa y expresamente confirmada, no será aceptada. El retraso en el pago, implicará la inclusión de los intereses bancarios, gastos de financiación y administrativos que partirán desde el día siguiente a la fecha vencimiento de la deuda.

La falta de pago en estos términos acordados implicará la suspensión de todos los pedidos en cartera sin previo aviso.

IMPAGADOS

En caso de producirse impagados quedarán retenidos los pedidos hasta que queden cancelados los mismos.

PORTES

La mercancía viaja a Portes Pagados siempre que la compra neta del pedido sea superior a: Península: 250 €

Baleares: 600 €

Canarias, Ceuta, Melilla: 1.200 €

Andorra: 500 €

RECEPCIÓN DE MATERIAL

Al recepcionar un envío deben comprobar que los bultos y los artículos coincidan con lo que pone en el albarán de entrega, así como el estado físico del material. Cualquier anomalía que observaran deberá ser comunicada al transportista, anotándolo al justificante de entrega i no haciéndose cargo del material. Si el material no ha podido ser revisado en el momento de la recepción del mismo, en las 24h siguientes pueden notificar a Fábrica la anomalía que detecten. Transcurridas las 24h. desde la recepción de la mercancía no se aceptará ninguna reclamación por rotura de material.

GARANTÍA MIRTAK

Contra cualquier defecto de fabricación de sus componentes siempre a contar desde la fecha de compra: Grifería: 3 AÑOS

Resto de material: 2 AÑOS

MIRTAK NO SE HARÁ CARGO DE

- Incorrecta instalación y/o manipulación
- Cortes y arañazos causados por impactos o accidentes del cliente.
- Desgaste normal del tiempo
- Deterioro por mantenimiento inadecuado.

DEVOLUCIONES

No se aceptarán devoluciones de mercancía si no son previamente autorizadas por Mirtak.

Las devoluciones de mercancía autorizadas se recepcionarán en nuestro almacén a portes pagados, o por nuestro representante comercial de la zona, con cupón adjunto y motivo devolución.

Si la devolución fuera por un defecto de fabricación se realizará a través de nuestro transportista habitual a portes debidos.

Una vez recepcionado el material en Fábrica se valorará el motivo de la misma y se procederá según haya acordado nuestro departamento comercial. Toda devolución que conlleve un abono sufrirá una depreciación en factura de:

- Si es del año en curso: -10% depreciación
- Si es anterior a dos años: -25% depreciación
- Si es anterior a tres años: -50% depreciación

* Siempre que no esté descatalogado

GENERAL CONDITIONS OF SALE

PRICES

Subject to any variation according to market conditions: prices do not include VAT. This Price Rate cancels the previous one and renders the previous ones without effect.

PAYMENT METHODS

All orders shipped out of the Spanish-Portuguese Peninsula (including its overseas regions), have the initial condition to pay in advance before the goods are shipped from any of our warehouses.

This condition will include a 2% discount to the total order amount.

The payment conditions indicated on the invoice are mandatory, each variation that has not been previously and expressly confirmed will not be accepted. Failure to pay in these agreed terms will imply the suspension of all portfolio orders without prior notice.

RECEPTION OF GOODS

When receiving a shipment, they must check that the packages and articles match what is stated on the delivery note, as well as the physical state of the material. Any anomaly observed must be communicated to the carrier, noting it on the delivery receipt and not taking charge of the material.

If the material has not been able to be reviewed at the time of receipt, in the following 24 hours they can notify the Factory of the anomaly they detected. After 24 hours. From the reception of the goods, no claim for material breakage will be accepted.

MIRTAK WARRANTY

Against any manufacturing defect of its components always counting from the date of purchase: Faucet: 3 YEARS Rest of material: 2 YEARS

MIRTAK WILL NOT BE CHARGED FOR

- Incorrect installation or use
- Cuts and scratches caused by impacts or customer accidents.
- Normal time of use
- Deterioration due to inadequate maintenance.

RETURNS

Merchandise returns will not be accepted if they are not previously authorized by Mirtak.

Returns of authorized merchandise will be received at our warehouse freight prepaid, or by our commercial representative in the area, with attached coupon and reason for return.

If the return is due to a manufacturing defect, it will be made through our usual carrier, postage due.

Once the material has been received at the Factory, the reason for the same will be assessed and the procedure will be as agreed by our sales department.

Any return that involves a credit will suffer an invoice depreciation of:

- If it is from the current year: -10% depreciation
- If it is prior to two years: -25% depreciation
- If it is older than three years: -50% depreciation

* As long as it is not out of catalogue

CATÁLOGO EN LÍNEA
ONLINE CATALOGUE



OFICINAS Y CENTRO LOGÍSTICO
OFFICE AND LOGISTIC CENTER

Polígono Industrial Girona - C. Morera, 6
17457 Riudellots de la Selva (Girona) Spain
Tel. 972 478 427
comercial@mirtak.com

FÁBRICA
FACTORY

Polígono Industrial San Miguel
C. Isaac Newton, 18
50830 Villanueva de Gallego (Zaragoza) Spain

